

LI	A	B
1162	579	205.5
1362	679	255.5
1562	779	305.5
1762	879	355.5
1962	979	405.5
2162	1079	455.5
2362	1179	505.5
2562	1279	555.5
2762	1379	605.5
2962	1479	655.5

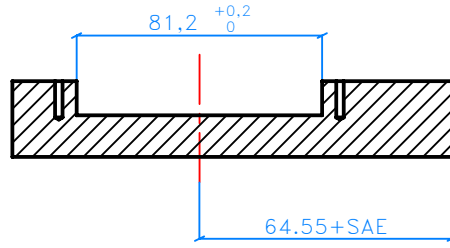

Sez. R-R

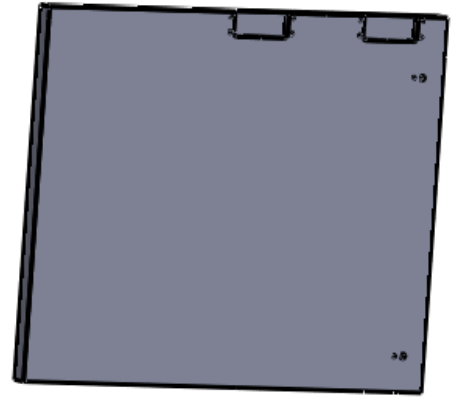
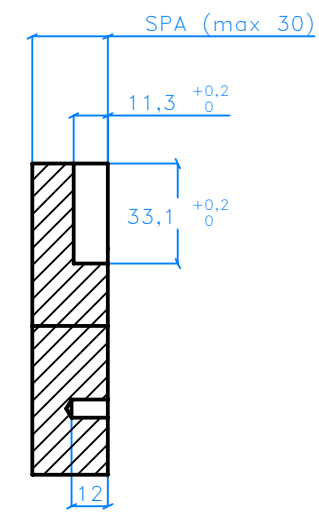
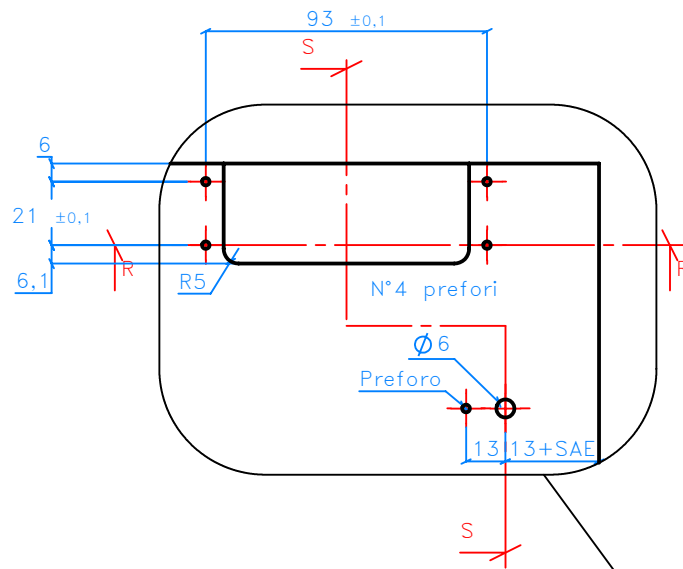

Sez. S-S

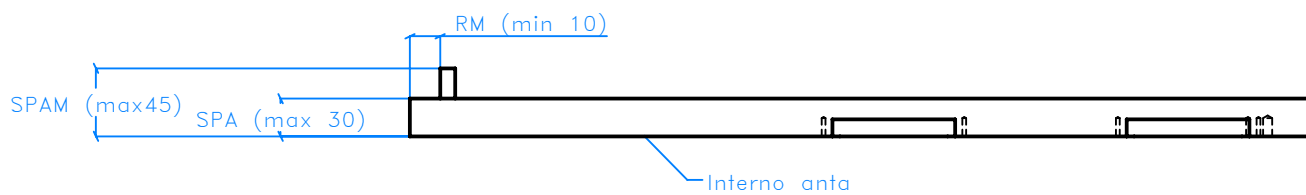
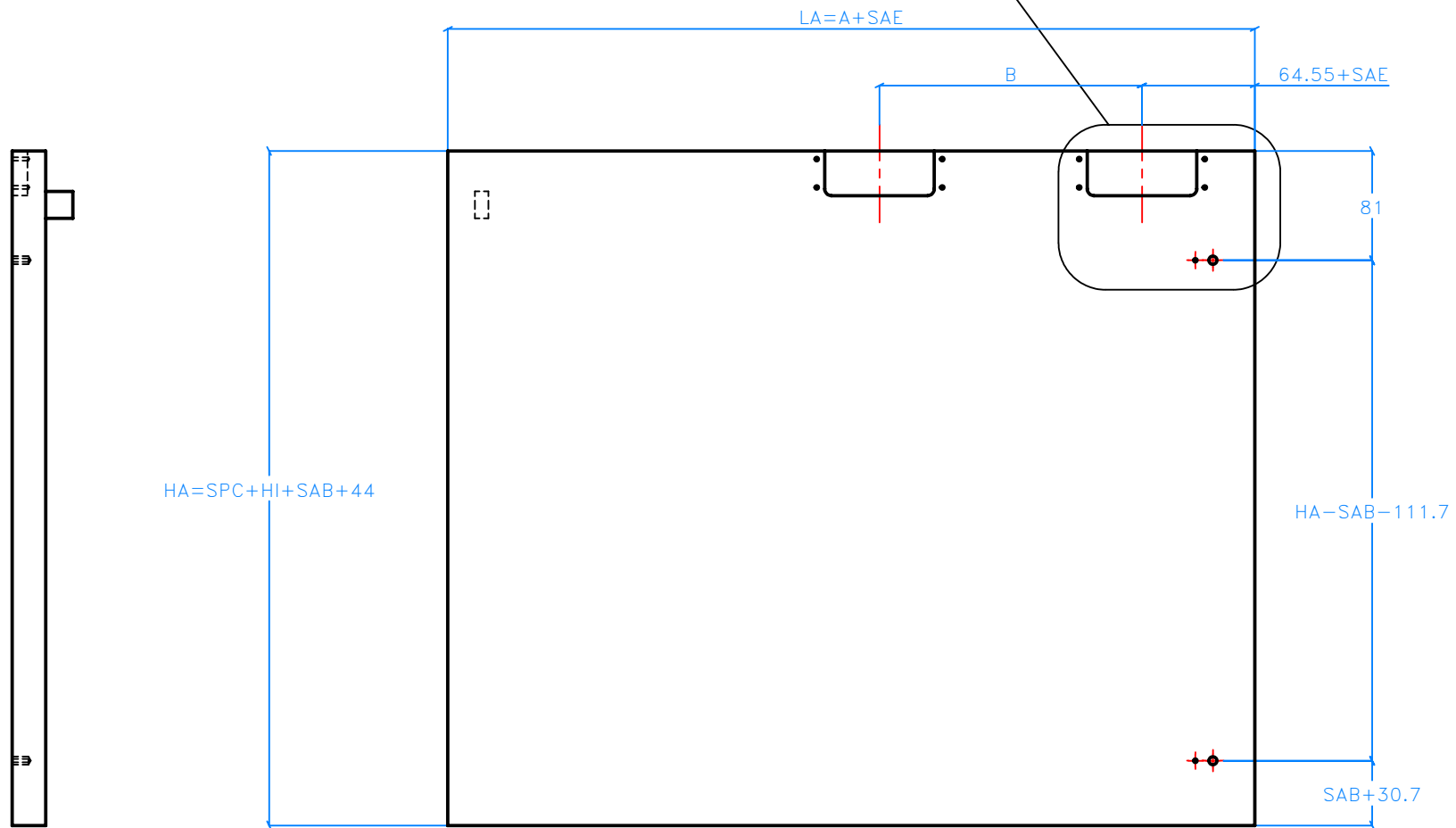

Interno anta



Bortoluzzi Lab	Disegno:	Serie: S20 PENSILE STOCK
	Descrizione: Slider Small S20; lavorazioni anta sinistra pensile Stock	
Materiale:		Scala 1:5 @A3
Trattamenti superf.:		Massa (gram.):
Riferimento tolleranze UNI: UNI .....		Disegnato da: D.S.
Disegno di proprietà della Bortoluzzi Lab s.r.l. vietata la riproduzione e la divulgazione		Controllato da:

SAE: max 48

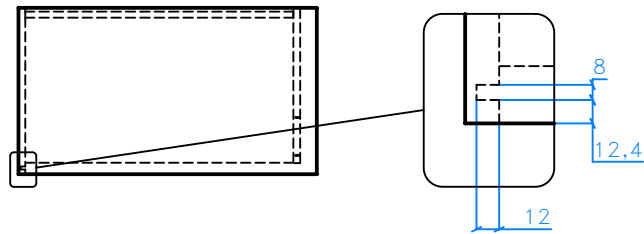
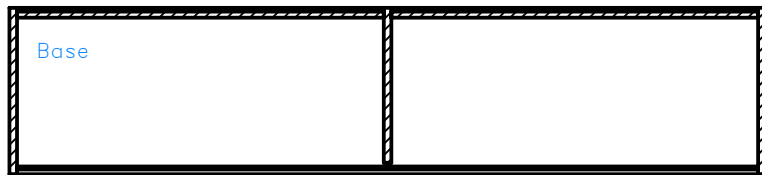
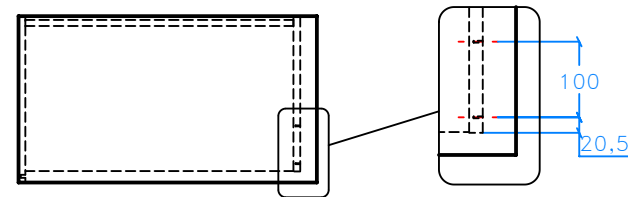
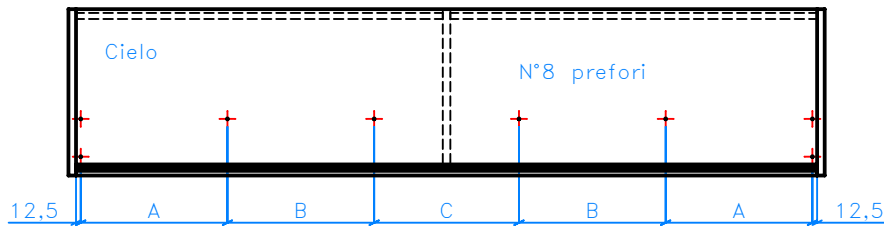
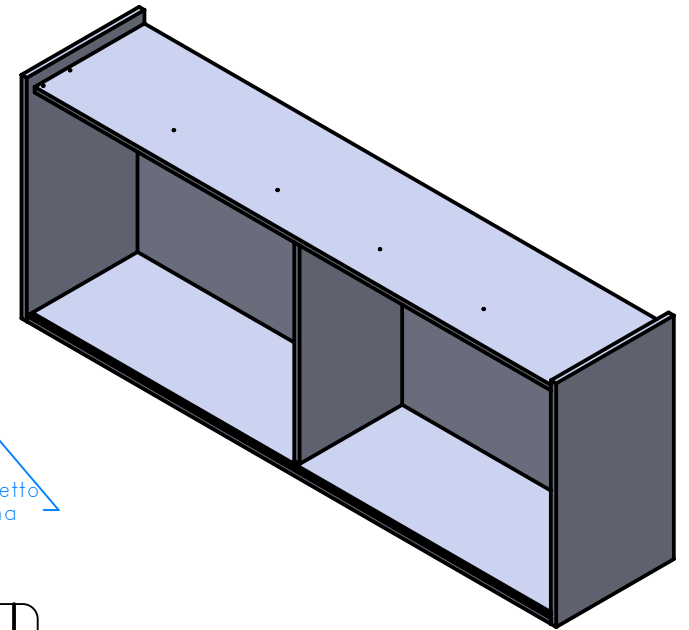
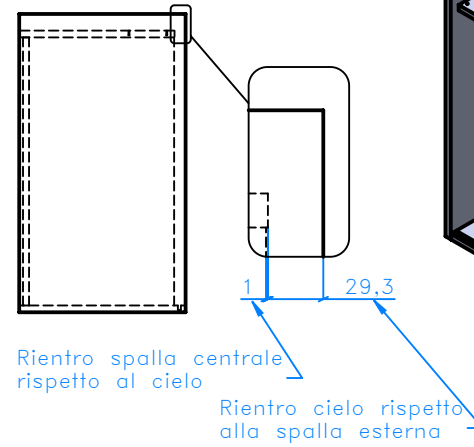
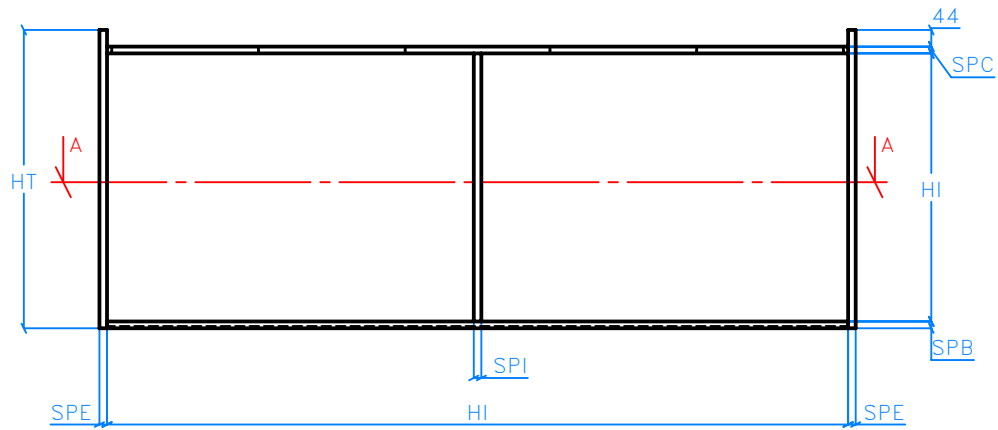

L'ANTA DESTRA E' SIMMETRICA



SEZ. A-A



LI	A	B	C
1162	208	246	229
1362	258	276	269
1562	307	307	309
1762	347	347	349
1962	387	387	389

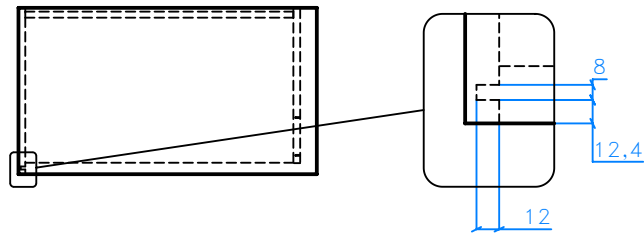
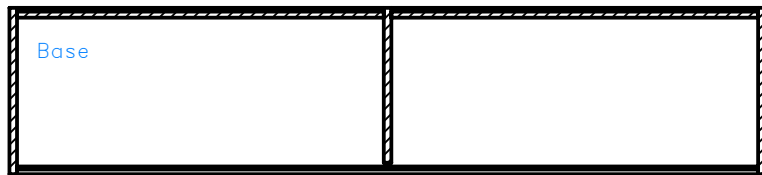
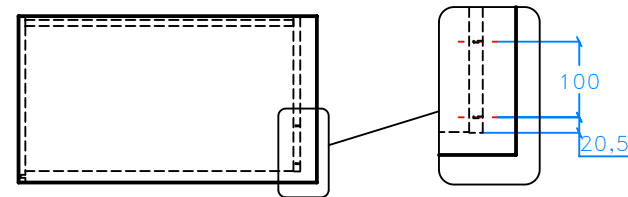
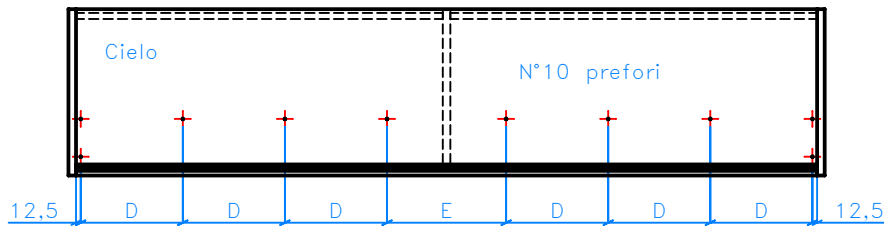
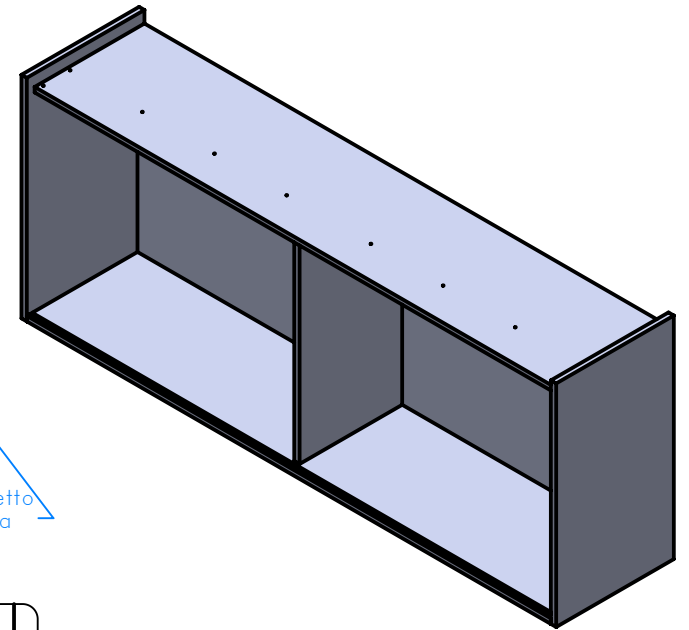
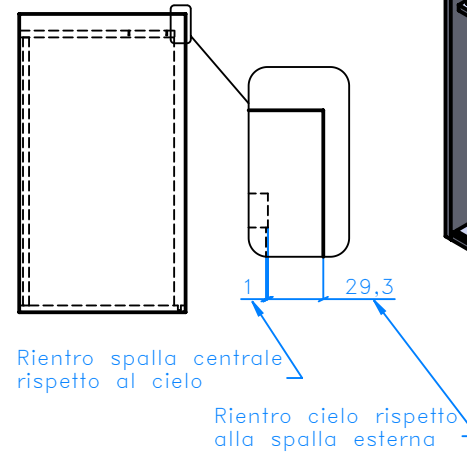
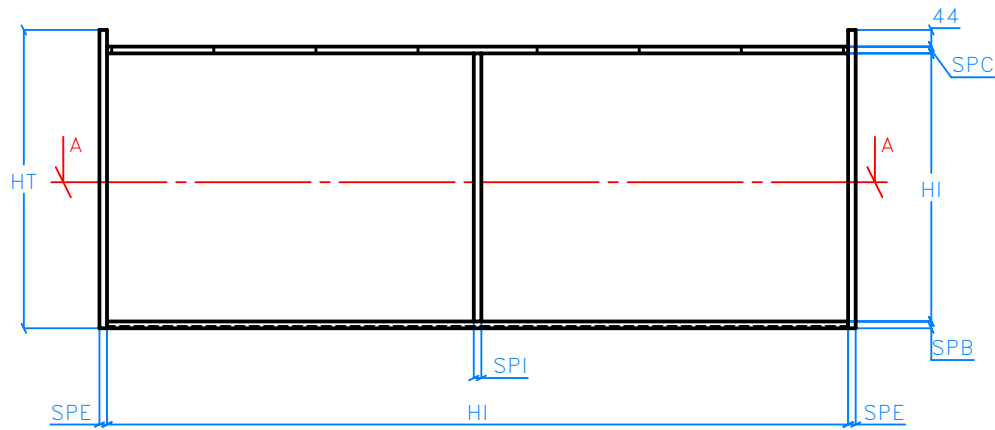

	Disegno:	Serie: S20 PENSILE STOCK
	Descrizione: Slider Small S20; lavorazioni pensile stock con LI da 1162 a 1962	Scala
Materiale:		
Trattamenti superf.:	Massa (gram.):	
Riferimento tolleranze UNI: -	Disegnato da: DS	
Disegno di proprietà della Bortoluzzi Lab s.r.l. vietata la riproduzione e la divulgazione	Controllato da: -	



SEZ. A-A



LI	D	E
2162	305	307
2362	333	339
2562	362	365
2762	391	391
2962	419	423

	Disegno:	Serie: S20 PENSILE STOCK
	Descrizione: Slider Small S20; lavorazioni pensile stock con LI da 2162 a 2962	
Materiale:		Scala
Trattamenti superf.:		
Riferimento tolleranze UNI: -		Massa (gram.):
Disegno di proprietà della Bortoluzzi Lab s.r.l. vietata la riproduzione e la divulgazione		Disegnato da: DS
		Controllato da: -