

 **ITALIANA**[®]
f e r r a m e n t a

 **MENGUAL**[®]

Flipper

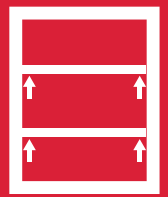

**SHELF
SUPPORTS**



FLIPPER

FLIPPER is a wood shelf support slotted into the shelf by making face borings.

The shelf has to be pushed downwards onto the side dowels, which can be placed or screwed into any required position.

The side dowels slot into the socket of the shelf supports and a click locks the shelf in position.

To provide a structural fastening to the furniture, screwed side dowels are required, so that the shelf flushes with the sides, due to the angled shape of the shelf support sockets.

All versions comply with the regulation: UNI EN 14749/05.



12 mm min.



UNI EN 14749/05



INSTALLATION

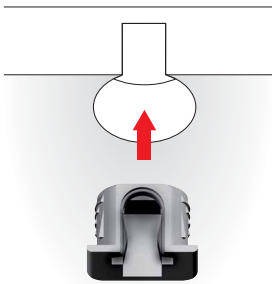

Assembling with smooth pin

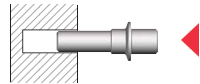

Assembling with threaded pin to achieve horizontal connection

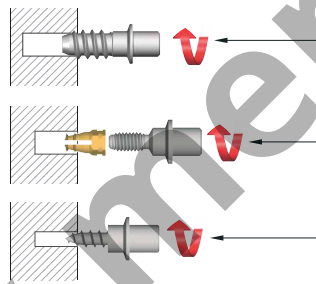

cross PZ2 screwdriver



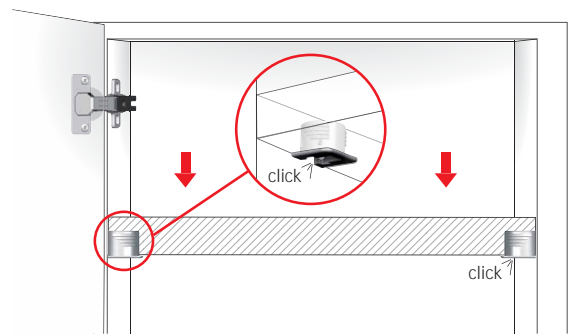
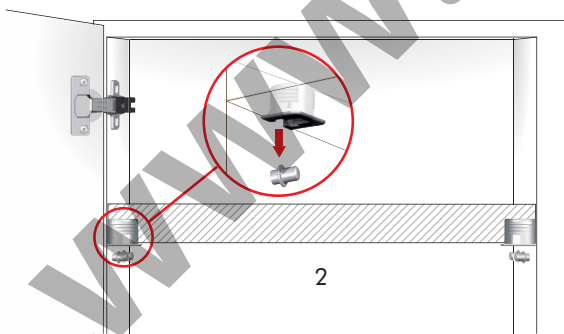
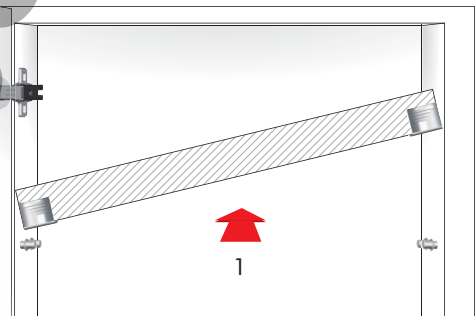

SHELF INSTALLATION

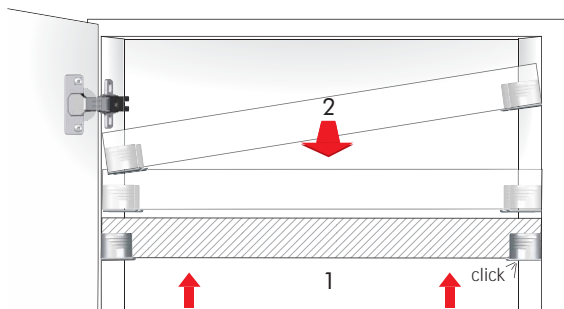

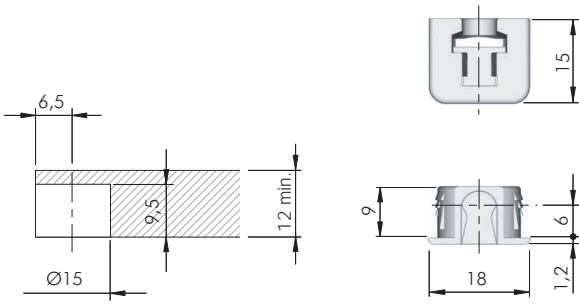





SHELF REMOVAL FOR NEW REPOSITIONING

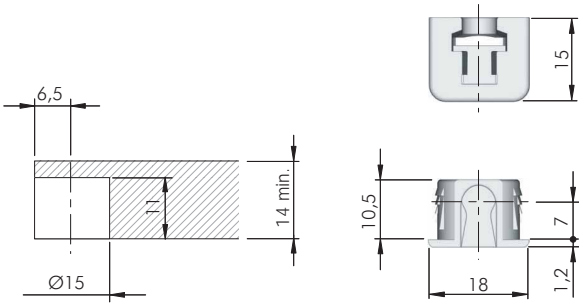







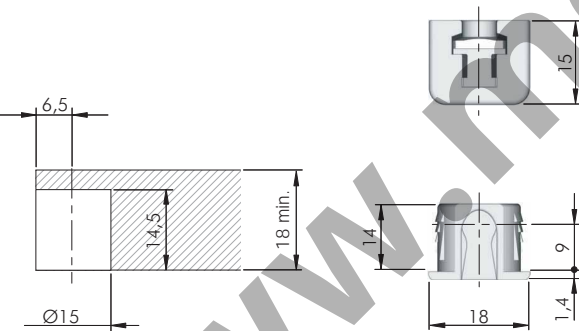

 = 12 mm + 
 EP  = 10.000 pcs.
 
10601010AB
10601010JG







 = 14 mm + 
 EP  = 10.000 pcs.
 
10601020AB
10601020JG

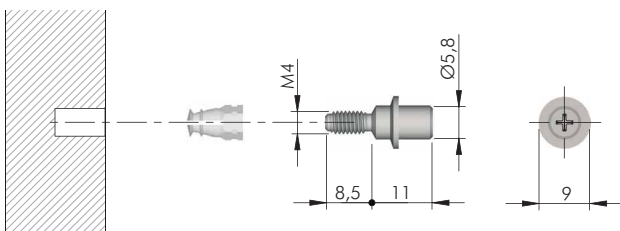

 = 18 mm + 
 EP  = 8000 pcs.
 
10601030AB
10601030JG



 = M4
 = PZ2
 ST  = 4000 pcs.
 
10602010ZN

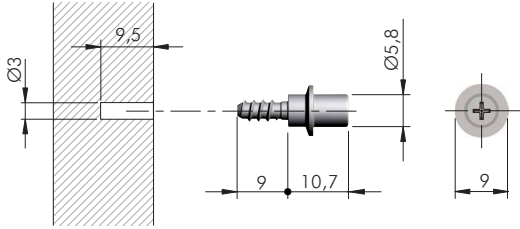

10603031ZN

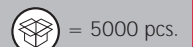
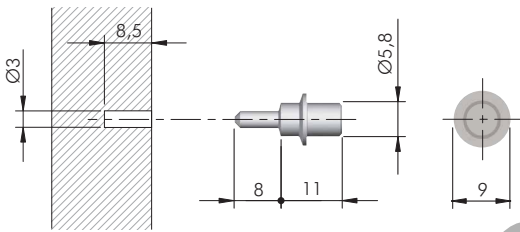

10605030ZN

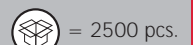
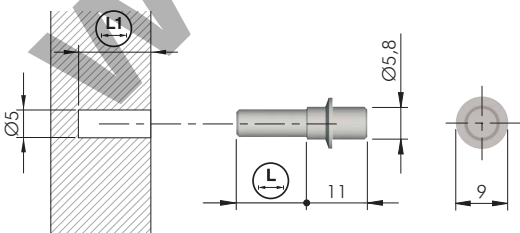

10605020ZN



12,5



13

10605010ZN

8,5

9

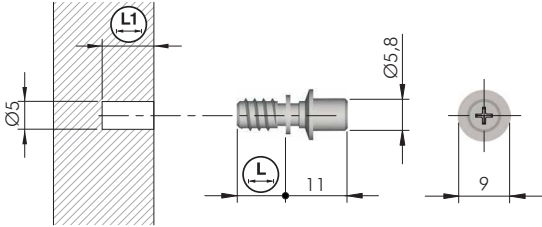

10604020ZN

7,5

8

5000

10604010ZN

8,8

9,3

2500

FLIPPER FIXING ACCESSORY

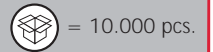
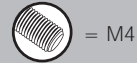
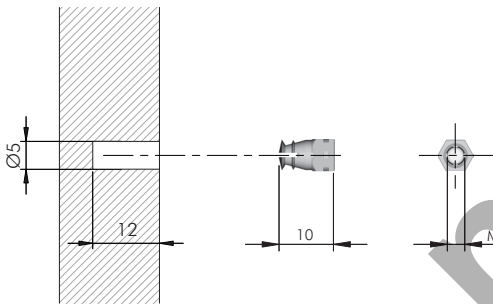

20502021HL

DRILL BIT FOR FLIPPER 12, 14, 18 mm

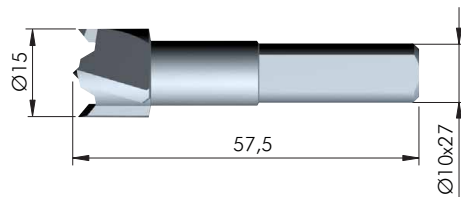
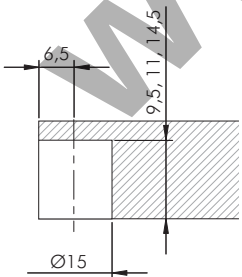

HSS

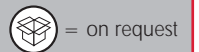

1065201000