

# STANLEY®

## 2 - Beam Self-Leveling Cross Line Laser

# CLLi



**77-117**

Please read these instructions before operating the product



Self-Leveling

GB

D

F

I

E

PT

NL

DK

SE

## Contents

1. Safety
2. Product Description
3. Specifications
4. Operating Instructions
5. Calibration
6. Maintenance and Care
7. Warranty

## Safety

### User Safety

Carefully read the Safety Instructions and User Manual before using this product. The person responsible for the instrument must ensure that all users understand and adhere to these instructions.

Retain this manual for future reference.

**IMPORTANT:** The following labels are on your laser tool for your convenience and safety. They indicate where the laser light is emitted by the level. **ALWAYS BE AWARE** of their location when using the level.



EN 60825-1

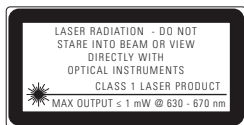

**DO NOT** remove any warning label(s) on the housing. This instrument must only be used for leveling and layout tasks as outlined in this manual.

**ALWAYS** make sure that any bystanders in the vicinity of use are made aware of the dangers of looking directly into the laser tool.

**DO NOT** use in combination with other optical instruments. Do not modify the instrument, or make manipulations or use in other applications than those described in the manual.

**DO NOT** look into the beam with optical aids, such as magnifiers, binoculars or Telescopes.

**DO NOT** stare into the laser beam or direct it towards other persons. Make sure the instrument is not set at eye level. Eye protection is normally afforded by natural aversion responses such as the blink reflex.

**DO NOT** direct the laser beam at other persons.

**ALWAYS** turn the laser tool "OFF" when not in use. Leaving the laser tool "ON" increases the risk of someone inadvertently staring into the laser beam.

**DO NOT** operate the laser tool in combustible areas such as in the presence of flammable liquids, gases or dust.

**DO NOT** disassemble the laser tool. There are no user serviceable parts inside. Disassembling the laser will void all warranties on the product. Do not modify the product in any way. Modifying the laser tool may result in hazardous laser radiation exposure.

**DO NOT** use this instrument in areas where a risk of explosion is present.

**NOTE:** Since the laser beam is of the focused type, ensure you check the beam's path over a relatively long distance and take all necessary precautions to ensure the beam cannot interfere with other persons.



## Battery Safety

---

**WARNING:** Batteries can explode or leak and can cause injury or fire. To reduce this risk:

**ALWAYS** follow all instructions and warnings on the battery label and package.

**DO NOT** short any battery terminals

**DO NOT** charge alkaline batteries.

**DO NOT** mix old and new batteries. Replace all of them at the same time with new batteries of the same brand and type.

**DO NOT** mix battery chemistries.

**DO NOT** dispose of batteries in fire.

**ALWAYS** keep batteries out of reach of children.

**ALWAYS** remove batteries if the device will not be used for several months.

**NOTE:** Ensure that the correct batteries as recommended are used.

**NOTE:** Ensure the batteries are inserted in the correct manner, with the correct polarity.

## End of Life

---

**DO NOT** dispose of this product with household waste.

**ALWAYS** dispose of batteries per local code.

**PLEASE RECYCLE** in line with local provisions for the collection and disposal of electrical and electronic waste under the WEEE Directive.



## Declaration of Conformity

---

The Stanley Works declares that the CE Mark has been applied to this product in accordance with the CE Marking Directive 93/68/EEC.

This product conforms with EN60825-1:2007.

For further details please refer to [www.stanleyworks.com](http://www.stanleyworks.com).



CE



ROHS Compliant

## Product Description

---

### Package Contents

---

1. Laser Unit
2. Tripod
3. L-Type Bracket
4. Pole Clamp (attaches to L-Type Bracket)
5. Laser Target
6. Carrying Case
7. Batteries (3 x AA)
8. User Manual



## Product Overview

---

### Laser Unit



1. Window for Cross Beam Laser
2. Transport Lock



3. Keyboard
4. Laser Warning Label
5. Battery Compartment Cover



6. 1/4 - 20 Threaded Mount



## Tripod

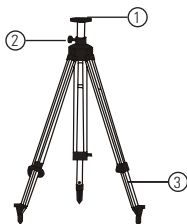

1. 1/4 - 20 Screw Mount
2. Elevator Column
3. Adjustable Legs

## L-Type Bracket

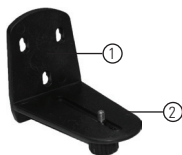

1. Keyhole Slots
2. 1/4 - 20 Screw Mount

## Pole Clamp

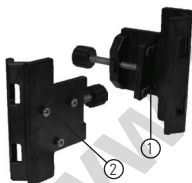

1. Clamp
2. 3 Pin Key



Leveling Accuracy:	≤ 4 mm / 10 m (≤ 5/32 in / 30 ft)
Horizontal / Vertical Accuracy	≤ 4 mm / 10 m (≤ 5/32 in / 30 ft)
Working Range:	Self-Leveling to ± 4°
Working Distance:	≤ 10 m (≤ 30 ft)
Laser Class:	Class 1
Laser Wavelength:	635 nm ± 5 nm
Operating Time:	16 h
Power Voltage:	4,5 V
Power Supply:	3 x AA Batteries (Alkaline)
IP Rating:	IP54
Operating Temperature Range:	-10° C to +40° C (+14° F to +104° F)
Storage Temperature Range:	-20° C to +60° C (-4° F to +140° F)
Weight (without Base and Batteries):	230 g (8 oz)
Size:	88 mm × 48 mm × 90 mm (3 1/2 in × 1 7/8 in × 3 1/2 in)







## Battery Installation / Removal

1. Turn laser unit to back. Open battery compartment cover by bending tab out to unlock.



2. Install / Remove batteries. Orient batteries correctly when placing into laser unit.



3. Close and lock battery compartment cover. Be sure tab snaps back into locking feature.



## Laser Unit



Laser ON / OFF

Self-leveling

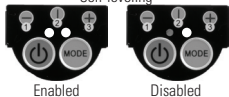

Enabled

Disabled



Laser Mode

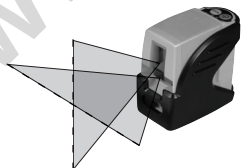

1. Transport lock in locked position. Self-leveling function is disabled.
2. Transport lock in unlocked position. Self-leveling function is enabled.
3. Press power key to power laser ON / OFF. Right LED lights green when laser power is on.
4. Left LED lights blue when laser power is on with self-leveling function disabled. LED is off when self-leveling function enabled.
5. Press laser mode key to toggle through available laser modes - horizontal only, vertical only, both horizontal and vertical.
6. Laser power and laser mode keys are always functional. Can be used when self-leveling function is both enabled or disabled.
7. Laser beam(s) blink to indicate the laser unit is out of the working range. Reposition laser unit to be more level.



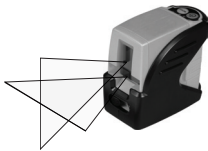

8. Laser beam(s) will dim when battery power is low. Replace batteries.

## Tripod

---



1. 1/4 - 20 screw mount to attach laser unit.



2. Foldable for easier transport.

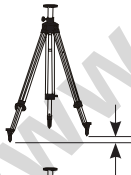

3. Legs are adjustable for uneven ground.



4. Elevator column adjustable for different heights.



## L-Type Bracket and Pole Clamp

---



1. 1/4 - 20 screw mount to attach laser unit. Allows for full 360° placement of the laser unit.



2. Fasten pole clamp to L-type bracket to allow use with tripod or other optional accessories.

## Applications

---

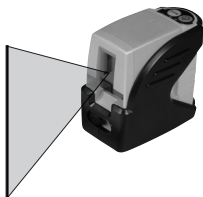

1. **Plumb:**  
Using the vertical laser beam, establish a vertical reference plane. Position the desired object(s) until they are aligned with the vertical reference plane to ensure object(s) are plumb.

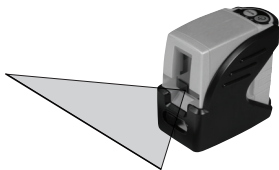

2. **Level:**  
Using the horizontal laser beam, establish a horizontal reference plane. Position the desired object(s) until they are aligned with the horizontal reference plane to ensure object(s) are level.

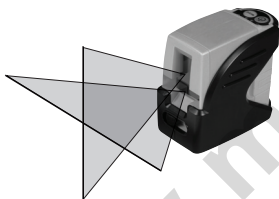

3. **Square:**  
Using both the vertical and horizontal laser beams, establish a point where the vertical and horizontal beams cross. Position the desired object(s) until they are aligned with both the vertical and horizontal laser beams to ensure object(s) are square.

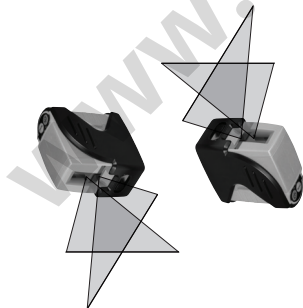

4. **Self-Leveling Disabled:**  
Disabling self-leveling function allows laser unit to project a rigid laser beam in any orientation.





**NOTE:** The laser unit has been calibrated at the time of manufacturing. Periodically check the accuracy of the laser unit to ensure that the calibrated specifications are maintained.

## Level Beam Accuracy

1. Place laser unit as shown with laser ON.  
Mark point  $P_1$  at cross.

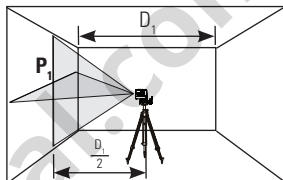

2. Rotate laser unit  $180^\circ$  and mark point  $P_2$  at cross.

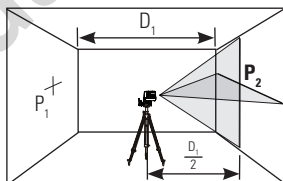

3. Move laser unit close to wall and mark point  $P_3$  at cross.

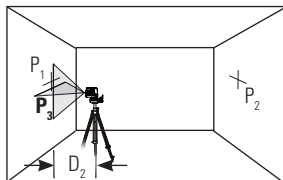

4. Rotate laser unit  $180^\circ$  and mark point  $P_4$  at cross.

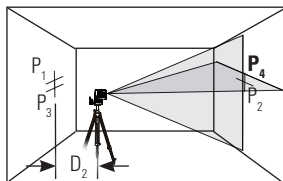

5. Measure the vertical distance from the floor to each point. Calculate the difference between distances  $D_{P_1}$  and  $D_{P_3}$  to get  $D_3$  and distances  $D_{P_2}$  and  $D_{P_4}$  to get  $D_4$ .

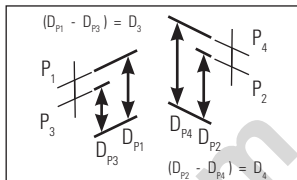

6. Calculate the maximum allowed offset distance and compare to the difference of  $D_3$  and  $D_4$  as shown in the equation. If the sum is not less than or equal to the calculated maximum offset distance the unit must be returned to your Stanley Distributor.

Maximum Offset Distance:

$$= 0,4 \frac{\text{mm}}{\text{m}} \times (D_1 \text{ m} - (2 \times D_2 \text{ m}))$$

Max  $= 0,0048 \frac{\text{in}}{\text{ft}} \times (D_1 \text{ ft} - (2 \times D_2 \text{ ft}))$

Compare:

$$D_3 - D_4 \leq \pm \text{Max}$$

Example:  $D_1 = 10 \text{ m}$ ,  $D_2 = 0,5 \text{ m}$

$$D_{P_1} = 30,75 \text{ mm}, D_{P_2} = 29 \text{ mm}, D_{P_3} = 30 \text{ mm}, D_{P_4} = 29,75 \text{ mm}$$

$$D_3 = (30,75 \text{ mm} - 30 \text{ mm}) = 0,75 \text{ mm}$$

$$D_4 = (29 \text{ mm} - 29,75 \text{ mm}) = -0,75 \text{ mm}$$

$$0,4 \frac{\text{mm}}{\text{m}} \times (10 \text{ m} - (2 \times 0,5 \text{ m})) = 3,6 \text{ mm} \text{ (maximum allowed offset distance)}$$

$$(0,75 \text{ mm}) - (-0,75 \text{ mm}) = 1,5 \text{ mm}$$

$$1,5 \text{ mm} \leq 3,6 \text{ mm} \text{ (TRUE, unit is within calibration)}$$

## Horizontal Beam Accuracy

1. Place laser unit as shown with laser ON. Aim vertical beam to first corner or reference point. Measure out half of the distance  $D_1$  and mark point  $P_1$ .

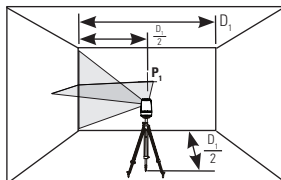

2. Rotate laser unit to other corner or reference point.

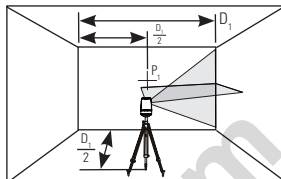

3. Measure the vertical distances between  $P_1$  and the horizontal beam from the 2nd location.

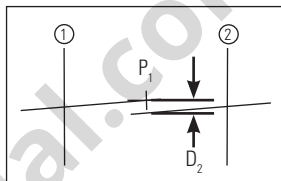

4. Calculate the maximum allowed offset distance and compare to  $D_2$ . If  $D_2$  is not less than or equal to the calculated maximum offset distance the unit must be returned to your Stanley Distributor.

Maximum Offset Distance:

$$\begin{aligned} \text{Max} &= 0,4 \frac{\text{mm}}{\text{m}} \times D_1, \text{m} \\ &= 0,0048 \frac{\text{in}}{\text{ft}} \times D_1, \text{ft} \end{aligned}$$

Compare:

$$D_2 \leq \text{Max}$$

Example:  $D_1 = 5 \text{ m}$ ,  $D_2 = 1 \text{ mm}$

$$0,4 \frac{\text{mm}}{\text{m}} \times 5 \text{ m} = 2 \text{ mm} \text{ (maximum allowed offset distance)}$$

$$1 \text{ mm} \leq 2 \text{ mm} \text{ (TRUE, unit is within calibration)}$$





## Vertical Beam Accuracy

1. Measure the height of a door jamb or reference point to get distance  $D_1$ . Place laser unit as shown with laser ON. Aim vertical beam towards door jamb or reference point. Mark points  $P_1$ ,  $P_2$ , and  $P_3$  as shown.

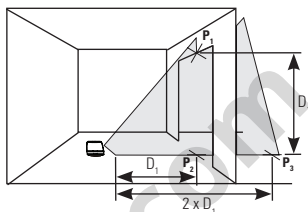

2. Move laser unit to opposite side of door jamb or reference point and align vertical beam with  $P_2$  and  $P_3$ .

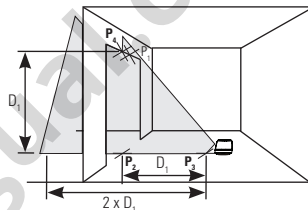

3. Measure the horizontal distances between  $P_1$  and the vertical beam from the 2nd location.

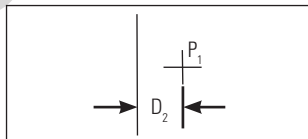

4. Calculate the maximum allowed offset distance and compare to  $D_2$ . If  $D_2$  is not less than or equal to the calculated maximum offset distance the unit must be returned to your Stanley Distributor.

### Maximum Offset Distance:

$$\begin{aligned} \text{Max} &= 0,8 \frac{\text{mm}}{\text{m}} \times D_1, \text{ m} \\ &= 0,0096 \frac{\text{in}}{\text{ft}} \times D_1, \text{ ft} \end{aligned}$$

### Compare:

$$D_2 \leq \text{Max}$$

Example:  $D_1 = 2 \text{ m}$ ,  $D_2 = 0,5 \text{ mm}$

$$0,8 \frac{\text{mm}}{\text{m}} \times 2 \text{ m} = 1,6 \text{ mm} \text{ (maximum allowed offset distance)}$$

$0,5 \text{ mm} \leq 1,6 \text{ mm}$  (**TRUE**, unit is within calibration)





Laser unit is not waterproof. **DO NOT** allow to get wet. Damage to internal circuits may result.

**DO NOT** leave laser unit in direct sunlight or expose it to high temperatures. The housing and some internal parts are made of plastic and may become deformed at high temperatures.

**DO NOT** store the laser unit in a cold environment. Moisture may form on interior parts when warming up. This moisture could fog up laser windows and cause corrosion of internal circuit boards.

When working in dusty locations, some dirt may collect on the laser window. Remove any moisture or dirt with a soft, dry cloth.

**DO NOT** use aggressive cleaning agents or solvents.

Store the laser unit in its case when not in use. If storing for extended time, remove batteries before storage to prevent possible damage to the instrument.





## One Year Warranty

Stanley Tools warrants its electronic measuring tools against deficiencies in materials and/or workmanship for one year from date of purchase.

Deficient products will be repaired or replaced, at Stanley Tools' option, if sent together with proof of purchase to:

Stanley UK Sales Limited  
Gowerton Road  
Brackmills, Northampton NN4 7BW

This Warranty does not cover deficiencies caused by accidental damage, wear and tear, use other than in accordance with the manufacturer's instructions or repair or alteration of this product not authorised by Stanley Tools.

Repair or replacement under this Warranty does not affect the expiry date of the Warranty.

To the extent permitted by law, Stanley Tools shall not be liable under this Warranty for indirect or consequential loss resulting from deficiencies in this product.

This Warranty may not be varied without the authorisation of Stanley Tools.

This Warranty does not affect the statutory rights of consumer purchasers of this product.

This Warranty shall be governed by and construed in accordance with the laws of England and Stanley Tools and the purchaser each irrevocably agrees to submit to the exclusive jurisdiction of the courts of England over any claim or matter arising under or in connection with this Warranty.

**IMPORTANT NOTE:** The customer is responsible for the correct use and care of the instrument. Moreover, the customer is completely responsible for periodically checking the accuracy of the laser unit, and therefore for the calibration of the instrument.

Calibration and care are not covered by warranty.

*Subject to change without notice*



## Inhaltsverzeichnis

1. Sicherheit
2. Produktbeschreibung
3. Technische Daten
4. Betriebsanleitung
5. Kalibrierung
6. Wartung und Pflege
7. Gewährleistung

## Sicherheit

### Benutzersicherheit

Lesen Sie vor der Verwendung dieses Produkts aufmerksam die Sicherheitshinweise und die Bedienungsanleitung. Die für das Instrument verantwortliche Person muss gewährleisten, dass sämtliche Benutzer die darin enthaltenen Anweisungen verstehen und befolgen.

Heben Sie diese Bedienungsanleitung auf.

**WICHTIG:** Die folgenden Etiketten auf Ihrem Lasergerät erleichtern Ihnen die Arbeit und dienen Ihrer Sicherheit. Sie zeigen an, wo Laserlicht ausgestrahlt wird. **Wenn Sie die Nivellierung benutzen, sollten Sie STETS** ihre Position KENNEN.



EN 60825-1



**Entfernen Sie KEINE** Warnetiketten vom Gehäuse. Dieses Instrument darf nur für die in dieser Anleitung beschriebenen Nivellier- und Layoutaufgaben verwendet werden.

**Sorgen Sie STETS** dafür, dass alle Personen in der Nähe des Geräts über die Gefahren bei direktem Blick in das Lasergerät informiert sind.

**NICHT** in Kombination mit anderen optischen Instrumenten verwenden. Verändern Sie das Instrument nicht, manipulieren Sie es nicht und verwenden Sie es für keine Anwendungen, die nicht in dieser Anleitung beschrieben sind.

**Blicken Sie NIEMALS** mit optischen Hilfsmitteln wie Lupen, Ferngläsern oder Teleskopen in den Strahl.

**NIEMALS** in den Laserstrahl starren oder den Laserstrahl direkt auf andere Personen richten. Achten Sie darauf, das Instrument nicht auf Augenhöhe aufzustellen. Für gewöhnlich erfolgt der Augenschutz durch natürliche Schutzreaktionen wie Blinzeln.

**Richten Sie den Laserstrahl NIEMALS** direkt auf andere Personen.

**Schalten Sie das Lasergerät IMMER** aus, wenn es nicht verwendet wird. Bei dauerhaft eingeschaltetem Lasergerät erhöht sich das Risiko, dass jemand unabsichtlich in den Laserstrahl blickt.

**Das Lasergerät darf NICHT** in hochgradig brennbaren Umgebungen eingesetzt werden, z. B. in der Nähe von entflammaren Flüssigkeiten, Gasen oder Staub.

**Zerlegen Sie das Lasergerät NIEMALS.** Im Innern befinden sich keine Komponenten, die vom Benutzer gewartet oder repariert werden könnten. Die Zerlegung des Lasers führt zum Verfall aller Garantien des Produkts. Das Produkt darf auf keine Weise modifiziert werden. Durch Modifizieren des Lasergeräts entsteht die Gefahr, sich gefährlicher Laserstrahlung auszusetzen.

**Verwenden Sie dieses Instrument NICHT** in Bereichen, in denen Explosionsgefahr gegeben ist.

**HINWEIS:** Da es sich um einen gebündelten Laserstrahl handelt, ist der Weg des Lasers unbedingt über eine relativ lange Strecke zu überprüfen, und es sind sämtliche erforderlichen Maßnahmen zu ergreifen, um zu gewährleisten, dass der Strahl nicht auf Personen treffen kann.



## Batteriesicherheit

---

**WARNUNG:** Batterien können explodieren oder auslaufen und Verletzungen oder Feuer verursachen. Folgende Maßnahmen reduzieren dieses Risiko:

**Befolgen Sie IMMER** sämtliche Anweisungen und Warnhinweise auf der Batterie und ihrer Verpackung.

**Schließen Sie Batterieanschlüsse NIEMALS** kurz.

**Laden Sie Alkali-Batterien NICHT** auf.

**Vermischen Sie NICHT** alte und neue Batterien. Ersetzen Sie alle gleichzeitig durch neue Batterien der gleichen Marke und des gleichen Typs.

**Vermischen Sie KEINE** chemisch unterschiedlichen Batterietypen.

**Entsorgen Sie Batterien NICHT** durch Verbrennen.

**Bewahren Sie Batterien IMMER** außerhalb der Reichweite von Kindern auf.

**Entfernen Sie IMMER** die Batterien, wenn das Gerät über mehrere Monate nicht zum Einsatz kommt.

**HINWEIS:** Achten Sie darauf, dass die richtigen, empfohlenen Batterien verwendet werden.

**HINWEIS:** Achten Sie darauf, dass Batterien richtig ausgerichtet eingelegt werden.

## Entsorgung

---

**Entsorgen Sie dieses Produkt NICHT** im Hausmüll.

**Entsorgen Sie Batterien IMMER** gemäß den vor Ort geltenden Bestimmungen.



**BITTE UM WIEDERVERWERTUNG** gemäß den örtlichen Bestimmungen für die Sammlung und Entsorgung von Elektro- und Elektronikabfall unter der WEEE-Richtlinie.

## Konformitätserklärung

---

Die Stanley Werke erklären, dass die CE-Kennzeichnung auf diesem Produkt in Übereinstimmung mit der CE-Kennzeichnungsrichtlinie 93/68/EWG angebracht wurde.

Dieses Produkt entspricht EN60825-1:2007.

Für weitere Einzelheiten besuchen Sie bitte [www.stanleyworks.com](http://www.stanleyworks.com).



CE



ROHS-kompatibel

## Produktbeschreibung

---

### Verpackungsinhalt

---

1. Lasergerät
2. Stativ
3. L-Halterung
4. Stabklemme (zur Anbringung an L-Halterung)
5. Laserziel
6. Tragetasche
7. Batterien (3 x AA)
8. Bedienungsanleitung



### Lasengerät



1. Öffnung für Kreuzlaser
2. Transportsicherung



3. Tastenfeld
4. Laserwarnetikett
5. Batteriefachabdeckung



6. 1/4-20 Anschlussgewinde



## Stativ

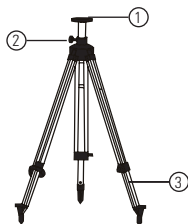

1. 1/4-20 Schraubenbefestigung
2. Hebesäule
3. Verstellbare Beine

## L-Halterung

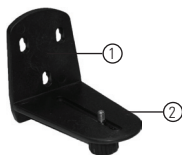

1. Schlüssellochschlitze
2. 1/4-20 Schraubenbefestigung

## Stabklemme

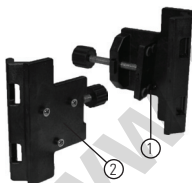

1. Klemme
2. 3 Passstifte



Nivelliergenauigkeit:	≤ 4 mm / 10 m (≤ 5/32 Zoll / 30 ft)
Horizontale / Vertikale Genauigkeit	≤ 4 mm / 10 m (≤ 5/32 Zoll / 30 ft)
Arbeitsbereich:	Selbstnivellierung auf ± 4°
Arbeitsentfernung:	≤ 10 m (≤ 30 ft)
Laserklasse:	Klasse 1
Laserwellenlänge:	635 nm ± 5 nm
Betriebsdauer:	16 h
Versorgungsspannung:	4,5 V
Stromversorgung:	3 x AA Batterien (Alkali)
IP-Klasse:	IP54
Betriebstemperaturbereich:	-10° C bis +40° C (+14° F bis +104° F)
Lagertemperaturbereich:	-20° C bis +60° C (-4° F bis +140° F)
Gewicht (ohne Rahmen und Batterien):	230 g (8 oz)
Größe:	88 mm × 48 mm × 90 mm (3 1/2 Zoll × 1 7/8 Zoll × 3 1/2 Zoll)



## Einlegen / Entfernen der Batterien

1. Gerät umdrehen. Batteriefachabdeckung durch Herausbiegen der Zunge öffnen, um diese zu entriegeln.
2. Batterien einlegen / entfernen. Batterien beim Einlegen in den Laser ordnungsgemäß ausrichten.
3. Batteriefachabdeckung schließen und verriegeln. Auf Einrasten der Zunge achten.



# Lasergerät



Laser EIN / AUS

Selbstnivellierend



Aktiviert



Deaktiviert



Lasermodus

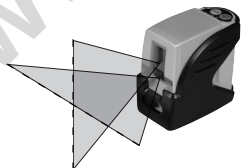

1. Transportsicherung in verriegelter Position. Selbstnivellierfunktion ist deaktiviert.
2. Transportsicherung in entriegelter Position. Selbstnivellierfunktion ist aktiviert.
3. Ein-/Ausschalter drücken, um Laser ein- und auszuschalten. Rechte LED leuchtet grün, wenn der Laser eingeschaltet ist.
4. Linke LED leuchtet blau, wenn der Laser eingeschaltet und die Selbstnivellierfunktion deaktiviert sind. LED erlischt, wenn die Selbstnivellierfunktion aktiviert ist.
5. Lasermodustaste drücken, um zwischen den verfügbaren Lasermodi umzuschalten - nur horizontal, nur vertikal, sowohl horizontal als auch vertikal.
6. Der Ein-/Ausschalter für den Laser und die Lasermodustaste funktionieren immer. Die Verwendung ist sowohl bei aktivierter als auch bei deaktivierter Selbstnivellierfunktion möglich.
7. Laserstrahl(en) blinkt/blinken, um anzuzeigen, dass das Lasergerät sich außerhalb des Arbeitsbereichs befindet. Gerät neu positionieren, sodass es ebener steht.



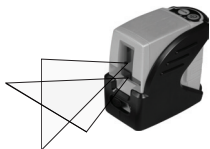

8. Laserstrahl(en) wird/werden schwächer, wenn der Batterieladestand niedrig ist. Batterien ersetzen.

## Stativ

---



1. 1/4-20 Schraubenbefestigung zur Anbringung des Lasergeräts.



2. Für einfacheren Transport zusammenklappbar.

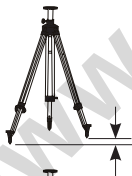

3. Die Beine sind für die Verwendung auf unebenmäßigem Gelände verstellbar.



4. Hebesäule ist auf verschiedene Höhen einstellbar.



## L-Halterung und Stabklemme

---



1. 1/4-20 Schraubenbefestigung zur Anbringung des Lasergeräts. Ermöglicht 360°-Schwenkbarkeit des Lasergeräts.



2. Stabklemme an L-Halterung befestigen, um Verwendung mit Stativ oder sonstigem optionalem Zubehör zu ermöglichen.

## Anwendungen

---

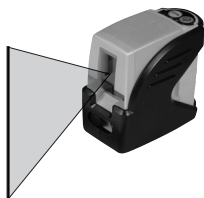

1. Lot:  
Mit dem vertikalen Laserstrahl eine vertikale Referenzebene einrichten. Position des/der gewünschten Objekts(e) ändern, bis diese(s) mit der vertikalen Referenzebene ausgerichtet ist/sind, um zu gewährleisten, dass das/die Objekt(e) im Lot ist/sind.

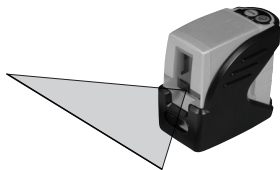

2. Nivellierung:  
Mit dem horizontalen Laserstrahl eine horizontale Referenzebene einrichten. Position des/der gewünschten Objekts(e) ändern, bis diese(s) mit der horizontalen Referenzebene ausgerichtet ist/sind, um zu gewährleisten, dass das/die Objekt(e) in der Waage ist/sind.

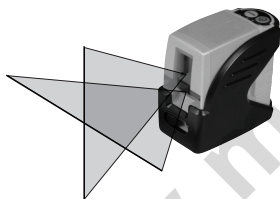

3. Rechteck:  
Sowohl mit dem vertikalen als auch dem horizontalen Laserstrahl einen Punkt einrichten, an dem sich der vertikale und horizontale Strahl kreuzen. Position des/der gewünschten Objekts(e) ändern, bis diese(s) sowohl mit dem vertikalen als auch dem horizontalen Laserstrahl ausgerichtet ist/sind, um zu gewährleisten, dass das/die Objekt(e) rechteckig ist/sind.

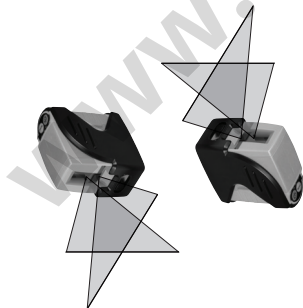

4. Selbstnivellierung deaktiviert:  
Das Deaktivieren der Selbstnivellierfunktion ermöglicht es dem Lasergerät, einen starren Laserstrahl in beliebiger Ausrichtung zu projizieren.





**HINWEIS:** Das Lasergerät wurde bei der Herstellung kalibriert. Überprüfen Sie regelmäßig die Genauigkeit des Lasers, um zu gewährleisten, dass die kalibrierten technischen Werte immer stimmen.

## Nivellierstrahlgenauigkeit

1. Gerät wie abgebildet mit eingeschaltetem Laser aufstellen. Punkt  $P_1$  am Kreuz markieren.

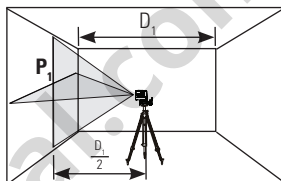

2. Gerät um  $180^\circ$  drehen und Punkt  $P_2$  am Kreuz markieren.

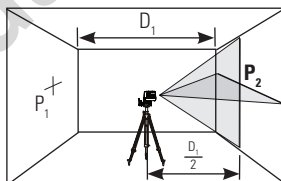

3. Gerät nah an die Wand verschieben und Punkt  $P_3$  am Kreuz markieren.

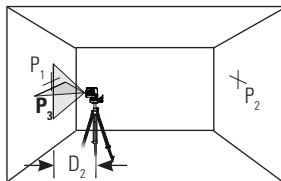

4. Gerät um  $180^\circ$  drehen und Punkt  $P_4$  am Kreuz markieren.

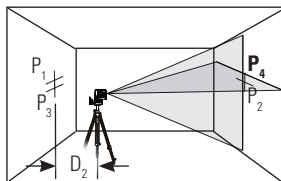



5. Vom Boden zu jedem Punkt vertikale Entfernung messen. Differenz zwischen den Entfernungen  $D_{P_1}$  und  $D_{P_3}$  berechnen, um  $D_3$  zu erhalten, bzw. zwischen den Entfernungen  $D_{P_2}$  und  $D_{P_4}$ , um  $D_4$  zu erhalten.

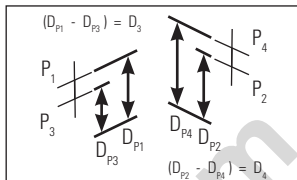

6. Maximal zulässigen Versatz berechnen und wie in der Gleichung gezeigt mit der Differenz von  $D_3$  und  $D_4$  vergleichen. Ist die Summe größer als der berechnete, maximal zulässige Versatz, muss das Gerät an Ihren Stanley-Händler retourniert werden.

Maximaler Versatz:

$$= 0,4 \frac{\text{mm}}{\text{m}} \times (D_1 \text{ m} - (2 \times D_2 \text{ m}))$$

$$\text{Max} = 0,0048 \frac{\text{Zoll}}{\text{ft}} \times (D_1 \text{ ft} - (2 \times D_2 \text{ ft}))$$

Vergleich:

$$D_3 - D_4 \leq \pm \text{Max}$$

Beispiel:  $D_1 = 10 \text{ m}$ ,  $D_2 = 0,5 \text{ m}$

$$D_{P_1} = 30,75 \text{ mm}, D_{P_2} = 29 \text{ mm}, D_{P_3} = 30 \text{ mm}, D_{P_4} = 29,75 \text{ mm}$$

$$D_3 = (30,75 \text{ mm} - 30 \text{ mm}) = 0,75 \text{ mm}$$

$$D_4 = (29 \text{ mm} - 29,75 \text{ mm}) = -0,75 \text{ mm}$$

$$0,4 \frac{\text{mm}}{\text{m}} \times (10 \text{ m} - (2 \times 0,5 \text{ m})) = 3,6 \text{ mm} \text{ (maximal zulässiger Versatz)}$$

$$(0,75 \text{ mm}) - (-0,75 \text{ mm}) = 1,5 \text{ mm}$$

$$1,5 \text{ mm} \leq 3,6 \text{ mm} \text{ (WAHR, Gerät ist innerhalb der Kalibrierungstoleranz)}$$

## Horizontale Strahlgenauigkeit

1. Gerät wie abgebildet mit eingeschaltetem Laser aufstellen. Vertikalen Strahl auf erste Ecke oder Referenzpunkt richten. Hälfte der Entfernung  $D_1$  messen und Punkt  $P_1$  markieren.

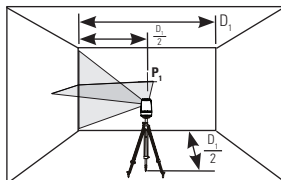

2. Laser auf andere Ecke oder Referenzpunkt drehen.

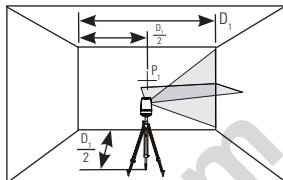

3. Vertikale Entfernungen zwischen  $P_1$  und dem horizontalen Strahl vom zweiten Standort messen.

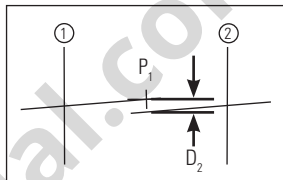

4. Maximal zulässigen Versatz berechnen und mit  $D_2$  vergleichen. Ist  $D_2$  größer als der berechnete, maximal zulässige Versatz, muss das Gerät an Ihren Stanley-Händler retourniert werden.

Maximaler Versatz:

$$= 0,4 \frac{\text{mm}}{\text{m}} \times D_1, \text{ m}$$

$$\text{Max} = 0,0048 \frac{\text{Zoll}}{\text{ft}} \times D_1, \text{ ft}$$

Vergleich:

$$D_2 \leq \text{Max}$$

Beispiel:  $D_1 = 5 \text{ m}$ ,  $D_2 = 1 \text{ mm}$

$$0,4 \frac{\text{mm}}{\text{m}} \times 5 \text{ m} = 2 \text{ mm} \text{ (maximal zulässiger Versatz)}$$

$$1 \text{ mm} \leq 2 \text{ mm} \text{ (WAHR, Gerät ist innerhalb der Kalibrierungstoleranz)}$$



## Vertikale Strahlgenauigkeit

1. Höhe eines Türgriffs oder Referenzpunkts messen, um Entfernung  $D_1$  zu erhalten. Gerät wie abgebildet mit eingeschaltetem Laser aufstellen. Vertikalen Strahl auf Türgriff oder Referenzpunkt richten. Punkte  $P_1$ ,  $P_2$  und  $P_3$  wie abgebildet markieren.

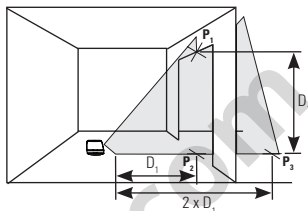

2. Gerät auf gegenüberliegende Seite des Türgriffs oder des Referenzpunkts verschieben und vertikalen Strahl auf  $P_2$  und  $P_3$  ausrichten.

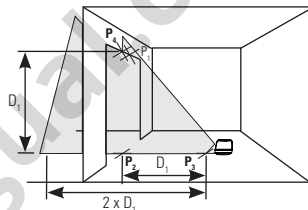

3. Horizontale Abstände zwischen  $P_1$  und dem vertikalen Strahl vom zweiten Standort messen.

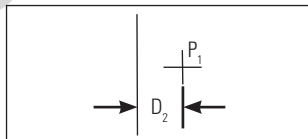

4. Maximal zulässigen Versatz berechnen und mit  $D_2$  vergleichen. Ist  $D_2$  größer als der berechnete, maximal zulässige Versatz, muss das Gerät an Ihren Stanley-Händler retourniert werden.

Maximaler Versatz:

$$\begin{aligned} &= 0,8 \frac{\text{mm}}{\text{m}} \times D_1, \text{ m} \\ \text{Max} &= 0,0096 \frac{\text{Zoll}}{\text{ft}} \times D_1, \text{ ft} \end{aligned}$$

Vergleich:

$$D_2 \leq \text{Max}$$

Beispiel:  $D_1 = 2 \text{ m}$ ,  $D_2 = 0,5 \text{ mm}$

$0,8 \frac{\text{mm}}{\text{m}} \times 2 \text{ m} = 1,6 \text{ mm}$  (maximal zulässiger Versatz)

$0,5 \text{ mm} \leq 1,6 \text{ mm}$  (**WAHR**, Gerät ist innerhalb der Kalibrierungstoleranz)



Das Lasergerät ist nicht wasserfest. **Lassen Sie es NICHT** nass werden. Andernfalls können Schäden an den internen Schaltungen entstehen.

**Setzen Sie das Lasergerät NICHT** direkter Sonneneinstrahlung oder hohen Temperaturen aus. Das Gehäuse und einige interne Teile bestehen aus Kunststoff und können sich bei hohen Temperaturen verformen.

**Lagern Sie das Lasergerät NICHT** in einer kalten Umgebung. Beim Erwärmen kann sich an internen Teilen Feuchtigkeit bilden. Die Feuchtigkeit kann Laserfenster beschlagen und zum Korrodieren interner Platinen führen.

Bei der Arbeit in staubiger Umgebung können sich am Laserfenster Verschmutzungen bilden. Beseitigen Sie Feuchtigkeit oder Verschmutzungen mit einem weichen, trockenen Tuch.

**Verwenden Sie KEINE** aggressiven Reinigungs- oder Lösungsmittel.

Bewahren Sie das Lasergerät bei Nichtgebrauch in der Tragetasche auf. Entfernen Sie vor einer längeren Lagerung die Batterien, um mögliche Schäden am Instrument zu vermeiden.





## Einjahresgarantie

Mit der vorliegenden Einjahresgarantie übernimmt Stanley Tools während eines Jahres ab dem Kaufdatum die Garantie für Material- und/oder Verarbeitungsdefekte an den elektronischen Messgeräten der Firma.

Defekte Produkte werden nach dem Ermessen von Stanley Tools repariert oder ersetzt unter der Bedingung, dass sie zusammen mit dem Kaufbeleg an folgende Adresse gesandt werden:

**Stanley Bostitch GmbH**  
Bützgenweg 2  
45239 Essen  
Germany  
geschickt werden.

Defekte, die aufgrund Beschädigung durch Unfall, Verschleiß oder Verwendung entgegen den Anweisungen des Herstellers oder aufgrund nicht von Stanley Tools genehmigten Reparaturen oder Veränderungen des Geräts entstehen, bleiben von der vorliegenden Garantie ausgeschlossen.

Reparatur oder Ersatz im Rahmen dieser Garantie beeinträchtigen die Garantiedauer nicht.

Soweit gesetzlich zulässig übernimmt Stanley Tools im Rahmen dieser Garantie keine Haftung für indirekte oder Folgeschäden, die durch Fehler an diesem Produkt entstehen.

Diese Garantie darf nicht ohne die Genehmigung von Stanley Tools geändert werden.

Die gesetzlichen Rechte der Käufer dieses Produktes bleiben von dieser Garantie unberührt.

Diese Garantie unterliegt englischem Recht, und sowohl Stanley Tools als auch der Käufer vereinbaren und akzeptieren hiermit unwiderruflich die ausschließliche Zuständigkeit der englischen Gerichte bei Ansprüchen oder Angelegenheiten, die sich aus oder in Verbindung mit dieser Garantie ergeben.

**WICHTIGER HINWEIS:** Der Kunde ist verantwortlich für die ordnungsgemäße Verwendung und Pflege des Geräts. Darüber hinaus ist der Kunde vollumfänglich für die regelmäßige Überprüfung der Genauigkeit des Lasergeräts und somit für die Kalibrierung des Instruments verantwortlich.

Die Garantie erstreckt sich nicht auf Kalibrierung und Pflege.

*Änderungen ohne Vorankündigung vorbehalten.*



## Table des matières

1. Sécurité
2. Description du produit
3. Spécifications techniques
4. Mode d'emploi
5. Calibrage
6. Maintenance et entretien
7. Garantie

## Sécurité

### Sécurité de l'utilisateur

Lire attentivement les consignes de sécurité et le manuel d'utilisation avant d'utiliser ce produit. La personne responsable de l'instrument doit s'assurer que tous les utilisateurs comprennent ces instructions et y adhèrent.

Conserver ce manuel pour future référence.

**IMPORTANT :** Les étiquettes suivantes sont apposées sur votre outil laser pour votre confort et votre sécurité. Elles indiquent l'endroit à partir duquel la lumière laser est émise par le niveau. **TOUJOURS GARDER À L'ESPRIT** cet emplacement lors de l'utilisation du niveau.



EN 60825-1

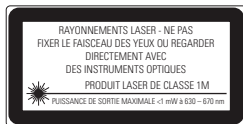

**NE PAS** retirer d'étiquette(s) d'avertissement figurant sur le logement. Cet instrument doit uniquement être utilisé pour des tâches de mise à niveau et de topologie, conformément aux instructions de ce manuel.

**TOUJOURS** s'assurer que toutes les personnes à proximité de l'appareil sont conscientes des risques auxquels elles s'exposent si elles regardent directement dans la direction de l'outil laser.

**NE PAS** utiliser conjointement avec d'autres instruments optiques. Ne pas modifier l'instrument, faire de manipulations ou utiliser pour d'autres applications que celles décrites dans le manuel.

**NE PAS** regarder en direction du faisceau avec des instruments optiques comme une loupe, des jumelles ou un télescope.

**NE PAS** fixer le faisceau laser et ne pas le diriger vers d'autres personnes. S'assurer que l'instrument n'est pas installé à hauteur d'œil. Les réactions d'aversion naturelles comme le réflexe de clignotement servent généralement de protection pour les yeux.

**NE PAS** orienter le faisceau laser vers d'autres personnes.

**TOUJOURS** éteindre l'outil laser lorsqu'il n'est pas utilisé (position OFF). Si l'outil laser est laissé en marche (position ON), les risques d'exposition non intentionnelle au faisceau laser sont accrus.

**NE PAS** utiliser l'outil laser dans des zones de stockage de combustibles, par exemple en présence de liquides, de gaz ou de poussières inflammables.

**NE PAS** démonter l'outil laser. Cet outil ne contient aucune pièce réparable par l'utilisateur. Le démontage du laser annulera toutes les garanties dont le produit bénéficie. Ne pas modifier le produit de quelque façon que ce soit. Les modifications apportées à l'outil laser pourraient entraîner une exposition à des rayonnements laser dangereux.

**NE PAS** utiliser cet instrument dans des secteurs où il existe un risque d'explosion.

**REMARQUE :** Le faisceau laser étant de type focalisé, il convient de contrôler la trajectoire du faisceau sur une distance relativement longue et de prendre toutes les précautions nécessaires pour s'assurer qu'il ne peut pas être dirigé vers d'autres personnes.



## Sécurité des piles

---

**AVERTISSEMENT** : Les piles peuvent exploser ou fuir, ceci pouvant entraîner des blessures ou un incendie. Pour réduire ces risques :

**TOUJOURS suivre** toutes les instructions et avertissements figurant sur l'étiquette et l'emballage des piles.

**NE PAS** court-circuiter les bornes des piles.

**NE PAS** charger les piles alcalines.

**Ne PAS** mélanger piles neuves et usagées. Les remplacer toutes à la fois par des piles neuves de même marque et de même type.

**NE PAS** mélanger des piles de composition chimique différente.

**NE PAS** jeter les piles au feu.

**TOUJOURS** conserver les piles hors de portée des enfants.

**TOUJOURS** retirer les piles s'il est prévu que l'appareil ne soit pas utilisé pendant plusieurs mois.

**REMARQUE** : S'assurer que les piles recommandées sont utilisées.

**REMARQUE** : S'assurer que les piles sont correctement insérées conformément à la polarité indiquée.

## Fin de vie

---

**NE PAS** jeter ce produit avec les déchets domestiques.

**TOUJOURS** mettre les piles au rebut conformément à la législation locale.



**VEUILLEZ RECYCLER** conformément aux dispositions locales concernant la collecte et l'élimination des déchets électriques et électroniques dans le cadre de la directive WEEE.





## Déclaration de conformité

---

The Stanley Works déclare que le marquage CE a été attribué à ce produit conformément à la directive 93/68/CEE.

Ce produit est conforme à EN60825-1:2007.

Pour plus d'informations, consulter [www.stanleyworks.com](http://www.stanleyworks.com).



## Description du produit

---



### Contenu du colis

---

1. Outil laser
2. Trépied
3. Support en L
4. Fixation pour perche (s'attache au support en L)
5. Cible de laser
6. Étui de transport
7. Piles (3 x AA)
8. Guide d'utilisation



## Aperçu du produit

---

### Outil laser



1. Fenêtre pour laser à faisceaux croisés
2. Verrou de transport



3. Clavier
4. Étiquette d'alerte laser
5. Couvercle du compartiment à piles



6. Monture filetée 1/4 - 20

## Trépied

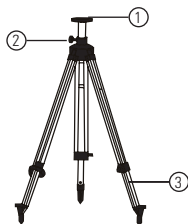

1. Monture à vis 1/4 - 20
2. Colonne élévatrice
3. Pieds réglables

## Support en L

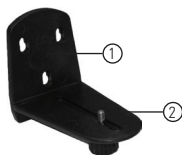

1. Encoches en trou de serrure
2. Monture à vis 1/4 - 20

## Fixation pour perche

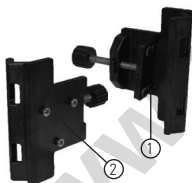

1. Fixation
2. Clé à 3 broches



Précision du nivellement :	≤ 4 mm / 10 m (≤ 5/32 po. / 30 pi.)
Précision horizontale / verticale	≤ 4 mm / 10 m (≤ 5/32 po. / 30 pi.)
Plage de fonctionnement :	Mise à niveau automatique jusqu'à ± 4°
Distance de fonctionnement	≤ 10 m (≤ 30 pi.)
Classe laser :	Classe 1
Longueur d'onde laser :	635 nm ± 5 nm
Durée de fonctionnement :	16 h
Tension d'alimentation :	4,5 V
Alimentation :	3 piles AA (alcaline)
Indice de protection :	IP54
Plage de température de fonctionnement :	De - 10° C à + 40° C (+ 14° F à + 104° F)
Plage de température de rangement :	De - 20° C à + 60° C (- 4° F à + 140° F)
Poids (sans la base et les piles) :	230 g (8 oz)
Taille :	88 mm × 48 mm × 90 mm (3 1/2 po. × 1 7/8 po. × 3 1/2 po.)





## Installation / retrait des piles

1. Retourner l'outil laser. Ouvrir le couvercle du compartiment à piles en pliant la languette pour déverrouiller.
2. Installer / retirer les piles. Correctement orienter les piles lorsqu'elles sont placées dans l'outil laser.
3. Fermer et verrouiller le couvercle du compartiment à piles. S'assurer que la languette se remet dans le dispositif de verrouillage.



## Outil laser

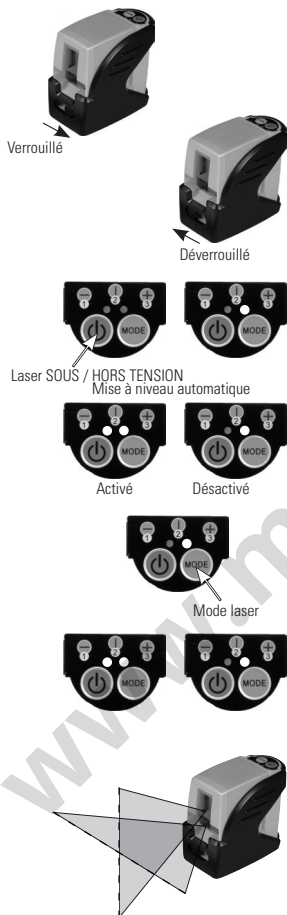

1. Verrou de transport en position verrouillée. La fonction de mise à niveau automatique est désactivée.
2. Verrou de transport en position déverrouillée. La fonction de mise à niveau automatique est activée.
3. Appuyer sur la touche d'alimentation pour mettre le laser sous / hors tension. La DEL droite s'allume en vert lorsque le laser est sous tension.
4. La DEL gauche s'allume en bleu lorsque le laser est sous tension avec la fonction de mise à niveau automatique désactivée. La DEL est éteinte lorsque la fonction de mise à niveau automatique est activée.
5. Appuyer sur la touche de mode laser pour basculer entre les modes laser disponibles - horizontal uniquement, vertical uniquement, horizontal et vertical.
6. Les touches d'alimentation et de mode laser fonctionnent en permanence. Peuvent être utilisées, que la fonction de mise à niveau automatique soit activée ou désactivée.
7. Le(les) faisceau(x) laser clignote(nt) pour indiquer que l'outil laser est en dehors de la plage de fonctionnement. Repositionner l'outil laser pour être davantage à niveau.



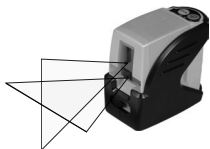

8. L'intensité du(des) faisceau(x) laser diminuera lorsque le niveau des piles est faible. Changer les piles.

## Trépied

---



1. Monture à vis 1/4 - 20 pour attacher l'outil laser.



2. Pliable pour un transport plus facile.

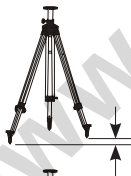

3. Les pieds sont réglables pour une utilisation sur une surface non régulière.



4. Colonne élévatrice réglable à différentes hauteurs.



## Support en L et fixation pour perche

---



1. Monture à vis 1/4 - 20 pour attacher l'outil laser. Permet un positionnement à 360 ° de l'outil laser.



2. Attacher la fixation pour perche au support en L pour permettre l'utilisation du trépied ou d'autres accessoires en option.



## Applications

---

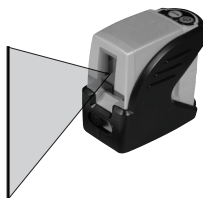

1. **Aplomb :**  
À l'aide du faisceau laser vertical, établir un plan de référence vertical. Positionner l'/les objet(s) souhaité(s) de sorte qu'il(s) soi(en)t aligné(s) sur le plan de référence vertical et qu'il(s) soi(en)t ainsi d'aplomb.

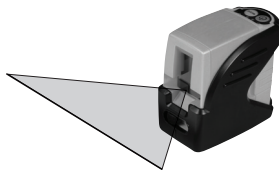

2. **Niveau :**  
À l'aide du faisceau laser horizontal, établir un plan de référence horizontal. Positionner l'/les objet(s) souhaité(s) de sorte qu'il(s) soi(en)t aligné(s) sur le plan de référence horizontal et qu'il(s) soi(en)t ainsi à niveau.

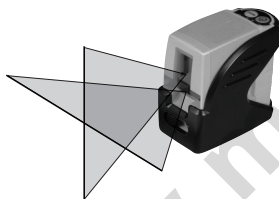

3. **Équerre :**  
À l'aide des faisceaux laser vertical et horizontal, établir un point où ces deux faisceaux se croisent. Positionner l'/les objet(s) souhaité(s) de sorte qu'il(s) soi(en)t aligné(s) à la fois sur les faisceaux vertical et horizontal et que cet/ces objet(s) soi(en)t ainsi mis en équerre.

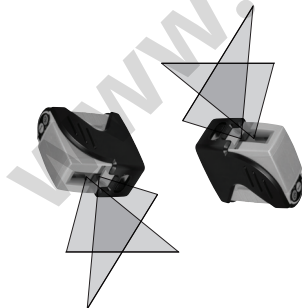

4. **Mise à niveau automatique désactivée :**  
Désactiver la fonction de mise à niveau automatique permet à l'outil laser de projeter un faisceau rigide dans n'importe quelle direction.





**REMARQUE :** l'outil laser a été calibré au moment de sa fabrication. Vérifier périodiquement la précision de l'outil laser afin de s'assurer que les spécifications calibrées sont maintenues

## Précision du faisceau de niveau

1. Positionner l'outil laser comme indiqué avec le laser en marche. Marquer le point de croisement  $P_1$ .

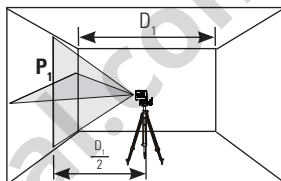

2. Pivoter l'outil laser de  $180^\circ$  et marquer le point de croisement  $P_2$ .

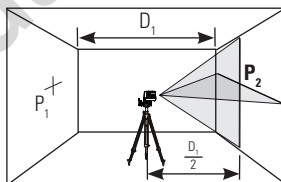

3. Rapprocher l'outil laser du mur et marquer le point de croisement  $P_3$ .

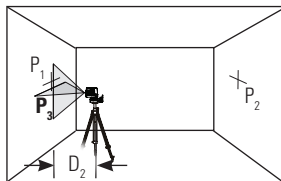

4. Pivoter l'outil laser de  $180^\circ$  et marquer le point de croisement  $P_4$ .

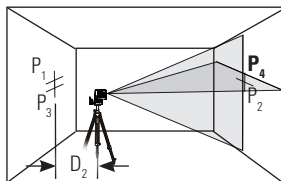

5. Mesurer la distance verticale entre le sol et chacun des points. Calculer la différence entre les distances  $D_{P_1}$  et  $D_{P_3}$  pour obtenir  $D_3$  et les distances  $D_{P_2}$  et  $D_{P_4}$  pour obtenir  $D_4$ .

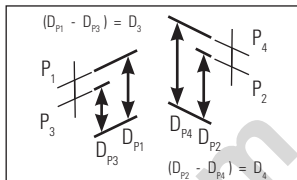

6. Calculer le décalage maximal autorisé et comparer à la différence entre  $D_3$  et  $D_4$  comme indiqué dans l'équation. Si la somme n'est pas inférieure ou égale au décalage maximal calculé, l'outil doit être renvoyé à votre distributeur Stanley.

Décalage maximal :

$$= 0,4 \frac{\text{mm}}{\text{m}} \times (D_1 \text{ m} - (2 \times D_2 \text{ m}))$$

Max

$$= 0,0048 \frac{\text{pi}}{\text{pi}} \times (D_1 \text{ pi.} - (2 \times D_2 \text{ pi.}))$$

Comparer :

$$D_3 - D_4 \leq \pm \text{Max}$$

Exemple :  $D_1 = 10 \text{ m}$ ,  $D_2 = 0,5 \text{ m}$

$$D_{P_1} = 30,75 \text{ mm}, D_{P_2} = 29 \text{ mm}, D_{P_3} = 30 \text{ mm}, D_{P_4} = 29,75 \text{ mm}$$

$$D_3 = (30,75 \text{ mm} - 30 \text{ mm}) = 0,75 \text{ mm}$$

$$D_4 = (29 \text{ mm} - 29,75 \text{ mm}) = -0,75 \text{ mm}$$

$$0,4 \frac{\text{mm}}{\text{m}} \times (10 \text{ m} - (2 \times 0,5 \text{ m})) = 3,6 \text{ mm} \text{ (décalage maximal autorisé)}$$

$$(0,75 \text{ mm}) - (-0,75 \text{ mm}) = 1,5 \text{ mm}$$

$$1,5 \text{ mm} \leq 3,6 \text{ mm} \text{ (VRAI, l'outil est dans les limites du calibre)}$$

## Précision du faisceau horizontal

1. Positionner l'outil laser comme indiqué avec le laser en marche. Pointer le faisceau vertical vers le premier coin au point de référence. Mesurer la moitié de la distance  $D_1$  et marquer le point  $P_1$ .

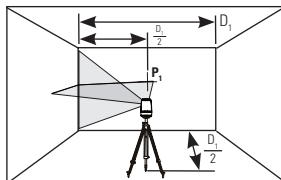

2. Pivoter l'outil laser vers l'autre coin ou point de référence.

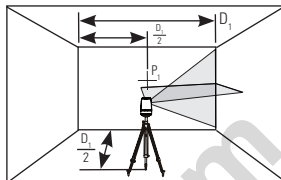

3. Mesurer les distances verticales entre  $P_1$  et le faisceau horizontal à partir du 2ème emplacement.

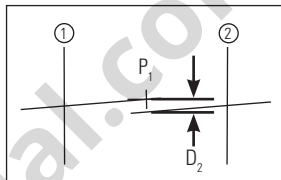

4. Calculer le décalage maximal autorisé et comparer à  $D_2$ . Si  $D_2$  n'est pas inférieure ou égale au décalage maximal calculé, l'outil doit être renvoyé à votre distributeur Stanley.

Décalage maximal :

$$= 0,4 \frac{\text{mm}}{\text{m}} \times D_1, \text{ m}$$

$$\text{Max} = 0,0048 \frac{\text{ppm}}{\text{pi.}} \times D_1, \text{ pi.}$$

Comparer :

$$D_2 \leq \text{Max}$$

Exemple :  $D_1 = 5 \text{ m}$ ,  $D_2 = 1 \text{ mm}$

$$0,4 \frac{\text{mm}}{\text{m}} \times 5 \text{ m} = 2 \text{ mm} \text{ (décalage maximal autorisé)}$$

$$1 \text{ mm} \leq 2 \text{ mm} \text{ (VRAI, l'outil est dans les limites du calibrage)}$$



## Précision du faisceau vertical

1. Mesurer la hauteur d'un montant de porte ou d'un point de référence pour obtenir la distance  $D_1$ . Positionner l'outil laser comme indiqué avec le laser en marche. Pointer le faisceau vertical vers le montant de porte ou point de référence. Marquer les points  $P_1$ ,  $P_2$  et  $P_3$  comme indiqué.

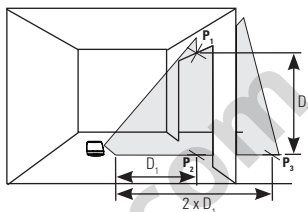

2. Déplacer l'outil laser vers le côté opposé du montant de porte ou point de référence et aligner le faisceau vertical sur  $P_2$  et  $P_3$ .

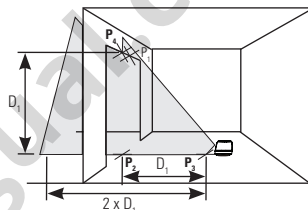

3. Mesurer les distances horizontales entre  $P_1$  et le faisceau vertical à partir du 2ème emplacement.

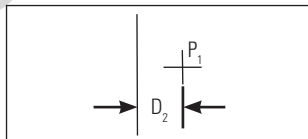

4. Calculer le décalage maximal autorisé et comparer à  $D_2$ . Si  $D_2$  n'est pas inférieure ou égale au décalage maximal calculé, l'outil doit être renvoyé à votre distributeur Stanley.

Décalage maximal :

$$\begin{aligned} &= 0,8 \frac{\text{mm}}{\text{m}} \times D_1, \text{ m} \\ \text{Max} &= 0,0096 \frac{\text{po}}{\text{pi}} \times D_1, \text{ pi.} \end{aligned}$$

Comparer :

$$D_2 \leq \text{Max}$$

Exemple :  $D_1 = 2 \text{ m}$ ,  $D_2 = 0,5 \text{ mm}$

$0,8 \frac{\text{mm}}{\text{m}} \times 2 \text{ m} = 1,6 \text{ mm}$  (décalage maximal autorisé)

$0,5 \text{ mm} \leq 1,6 \text{ mm}$  (**VRAI**, l'outil est dans les limites du calibrage)





L'outil laser n'est pas étanche. **NE PAS** laisser pénétrer d'humidité, au risque d'endommager les circuits internes.

**NE PAS** laisser l'outil laser à la lumière directe du soleil et ne pas l'exposer à des températures élevées. Le logement et certaines pièces internes sont en plastique et elles peuvent par conséquent être déformées à des températures élevées.

**NE PAS** ranger l'outil laser dans un environnement froid, car de l'humidité peut se former sur les parties intérieures lorsqu'il se réchauffe. Cette humidité pourrait voiler les fenêtres laser et entraîner la corrosion des cartes de circuit imprimé internes.

Si l'outil est utilisé dans des endroits poussiéreux, de la saleté peut s'accumuler sur la fenêtre laser. Retirer toute humidité ou saleté avec un chiffon doux et sec.

**NE PAS** utiliser d'agent nettoyant ou de dissolvant agressif.

Ranger l'outil dans son étui en cas de non utilisation. S'il est rangé pendant une période prolongée, retirer les piles au préalable afin d'éviter d'endommager l'instrument.





Stanley Tools garantit ses outils de mesure électroniques contre tout défaut matériel ou vice de fabrication pendant un an à compter de la date d'achat par l'utilisateur final auprès d'un revendeur STANLEY. La facture établie à cette occasion vaut preuve d'achat.

Le produit défectueux doit être retourné dans son emballage d'origine à l'adresse suivante, accompagnés d'une copie du ticket de caisse :

## **Stanley Tools France**

24, rue Auguste Jouchoux  
BP 1579  
25 009 Besançon

Après diagnostic du Service Après Vente STANLEY, seul compétent à intervenir sur le produit défectueux, celui-ci sera réparé ou remplacé par un modèle identique ou par un modèle équivalent correspondant à l'état actuel de la technique, selon la décision de STANLEY.

Si la réparation envisagée ne devait pas rentrer dans le cadre de la garantie, un devis sera établi par le Service Après vente de STANLEY et envoyé au client pour acceptation préalable, chaque prestation réalisée hors garantie donnant lieu à facturation.

Après diagnostic du Service Après Vente STANLEY, seul compétent à intervenir sur le produit défectueux, celui-ci sera réparé ou remplacé par un modèle identique ou par un modèle équivalent correspondant à l'état actuel de la technique, selon la décision de STANLEY.

Si la réparation envisagée ne devait pas rentrer dans le cadre de la garantie, un devis sera établi par le Service Après vente de STANLEY et envoyé au client pour acceptation préalable, chaque prestation réalisée hors garantie donnant lieu à facturation.

Cette garantie ne couvre pas les dommages, accidentels ou non, générés par la négligence ou une mauvaise utilisation de ce produit, ou résultant d'un cas de force majeure.

L'usure normale de ce produit ou de ses composants, conséquence de l'utilisation normale de ce produit sur un chantier, n'est pas couverte dans le cadre de la garantie STANLEY.

Toute intervention sur les produits, autre que celle effectuée dans le cadre normale de l'utilisation de ces produits ou par le Service Après vente STANLEY, entraîne la nullité de la garantie.

De même, le non respect des informations contenues dans le mode d'emploi entraîne de fait la suppression de la garantie. La garantie ne couvre pas les dommages provoqués par des causes d'origine externe au Produit, (vol, chute, foudre, inondation, incendie, produit endommagé pendant le transport, ...).

La mise en jeu de la présente garantie dans le cadre d'un échange ou d'une réparation ne génère pas d'extension de la période de garantie, qui demeure en tout état de cause, la période d'un an initiée lors de l'achat du produit STANLEY par l'utilisateur final.

Sauf disposition légale contraire, la présente garantie représente l'unique recours du client à l'encontre de STANLEY pour la réparation des vices affectant ce produit. STANLEY exclue donc tout autre responsabilité au titre des dommages matériels et immatériels, directs ou indirects, et notamment la réparation de tout préjudice financier découlant de l'utilisation de ce produit.



Indépendamment de la garantie contractuelle STANLEY, l'Utilisateur bénéficie des dispositions des articles 1641 à 1649 du Code Civil relatifs à la garantie des vices cachés. Lorsque l'Utilisateur est un consommateur il bénéficie également des dispositions des articles L.211-4 à L.211-14 du Code de la Consommation relatifs aux défauts de conformité.

Article 1641 du Code Civil « Le vendeur est tenu de la garantie à raison des défauts cachés de la chose vendue qui la rendent impropre à l'usage auquel on la destine, ou qui diminuent tellement cet usage que l'acheteur ne l'aurait pas acquise, ou n'en aurait donné qu'un moindre prix, s'il les avait connus. »

Article 1648 alinéa 1 du Code Civil : « L'action résultant des vices rédhibitoires doit être intentée par l'acquéreur dans un délai de deux ans à compter de la découverte du vice. »

Article L.211-4 du Code de la Consommation : « Le vendeur est tenu de livrer un bien conforme au contrat et répond des défauts de conformité existant lors de la délivrance. Il répond également des défauts de conformité résultant de l'emballage, des instructions de montage ou de l'installation lorsque celle-ci a été mise à sa charge par le contrat ou a été réalisée sous sa responsabilité ». La présente garantie ne limite en rien, ni ne supprime, les droits du client non professionnel, issus des articles 1641 et suivants du Code Civil relatifs à la garantie légale des vices cachés.

La présente garantie doit être appliquée et interprétée conformément à la législation française. Stanley Tools et l'acheteur acceptent de se soumettre sans appel à la seule juridiction des tribunaux français en cas de litige survenant dans le cadre ou en connexion avec la présente garantie.





[www.mengual.com](http://www.mengual.com)



## Indice

1. Sicurezza
2. Descrizione del prodotto
3. Specifiche
4. Istruzioni sul funzionamento
5. Calibrazione
6. Manutenzione e cura
7. Garanzia

## Sicurezza

### Sicurezza dell'utente

Leggere attentamente le Istruzioni di sicurezza e il Manuale per l'utente prima di utilizzare questo prodotto. La persona responsabile dello strumento deve assicurarsi che tutti gli utenti comprendano e seguano queste istruzioni.

Conservare questo manuale per future consultazioni.

**IMPORTANTE:** le seguenti etichette poste sull'apparecchiatura laser servono per facilitarne l'uso e per la sicurezza. Esse indicano dove la luce laser viene emessa dalla livella. È importante essere **SEMPRE CONSAPEVOLI** della loro posizione quando si utilizza la livella.



EN 60825-1

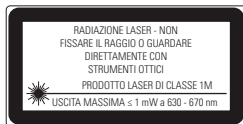

**NON** rimuovere nessuna etichetta sulla parte esterna. Questo strumento deve essere utilizzato unicamente per lavori di livellamento e tracciatura come descritto in questo manuale.

**ASSICURARSI SEMPRE** che qualsiasi persona nelle vicinanze dell'area di utilizzo sia a conoscenza dei rischi derivanti dal guardare direttamente l'apparecchiatura laser.

**NON** utilizzare in combinazione con altri strumento ottici. Non modificare o manipolare lo strumento, né utilizzare in applicazioni diverse da quelle descritte nel manuale.

**NON** guardare nel raggio con strumenti ottici, quali lenti d'ingrandimento, binocoli o telescopi.

**NON** fissare il raggio laser e non rivolgerlo verso altre persone. Assicurarsi che lo strumento non sia posizionato al livello degli occhi. Solitamente gli occhi si proteggono con una reazione naturale, come il riflesso di battere le palpebre.

**NON** rivolgere il raggio laser verso altre persone.

**SPEGNERE SEMPRE** l'apparecchiatura laser quando non viene utilizzata. Se si lascia l'apparecchiatura laser accesa, si aumenta il rischio di guardare inavvertitamente all'interno del raggio laser.

**NON** utilizzare l'apparecchiatura laser in aree in cui è presente del combustibile, come ad esempio in presenza di liquidi infiammabili, gas o polveri.

**NON** smontare l'apparecchiatura laser. All'interno non sono presenti componenti la cui manutenzione può essere eseguita dall'utente. Lo smontaggio del laser farà decadere la garanzia del prodotto. Non modificare in nessun modo il prodotto. La modifica dell'apparecchiatura laser potrebbe causare l'esposizione a radiazioni pericolose.

**NON** utilizzare questo strumento in aree in cui vi è rischio di esplosioni.

**NOTA:** poiché il raggio laser è di tipo focalizzato, assicurarsi di controllare il percorso del raggio su una distanza relativamente lunga e prendere tutte le precauzioni necessarie per assicurarsi che il raggio non possa interferire con altre persone.



## Sicurezza delle batterie

---

**ATTENZIONE:** le batterie possono esplodere o avere fuoriuscite e possono provocare lesioni o incendi. Per ridurre questo rischio:

**ATTENERSI SEMPRE** a tutte le istruzioni e agli avvisi presenti sull'etichetta della batteria e sulla confezione.

**NON** provocare il corto circuito dei terminali della batteria

**NON** ricaricare le batterie alcaline.

**NON** usare contemporaneamente batterie nuove e vecchie. Sostituire tutte contemporaneamente con batterie nuove della stessa marca e dello stesso tipo.

**NON** usare batterie con sostanze chimiche differenti.

**NON** smaltire le batterie nel fuoco.

**TENERE SEMPRE** le batterie fuori dalla portata dei bambini.

**RIMUOVERE SEMPRE** le batterie se il dispositivo non sarà utilizzato per diversi mesi.

**NOTA:** assicurarsi che vengano utilizzate le batterie giuste come raccomandato.

**NOTA:** assicurarsi che le batterie siano inserite nel modo giusto, con la polarità corretta.

## Fine vita utile

---

**NON** smaltire questo prodotto con i rifiuti domestici.

**SMALTIRE SEMPRE** le batterie nel rispetto delle norme locali.



**RICICLARE** rispettando le norme locali per la raccolta e lo smaltimento di rifiuti elettrici ed elettronici in conformità con la Direttiva sui rifiuti di apparecchi elettrici ed elettronici (WEEE).



## Dichiarazione di conformità

---

Stanley Works dichiara che a questo prodotto è stato applicato il marchio CE in conformità alla Direttiva sul marchio CE 93/68/CEE.

Questo prodotto è conforme alla EN60825-1:2007.

Per ulteriori informazioni, consultare il sito [www.stanleyworks.com](http://www.stanleyworks.com).



EN 60825-1



Conforme alla  
Direttiva sulla  
restrizione d'uso delle  
sostanze pericolose  
(RoHS)

## Descrizione del prodotto

---

### Contenuto della confezione

---

1. Unità laser
2. Cavalletto
3. Supporto a L
4. Morsetto dell'asta (si fissa al supporto a L)
5. Obiettivo laser
6. Valigetta per il trasporto
7. 3 batterie AA
8. Manuale per l'utente



## Presentazione del prodotto

---

### Unità laser



1. Finestra per laser con raggio incrociato
2. Bloccaggio per il trasporto



3. Tastiera
4. Etichetta di avvertenza per il laser
5. Coperchio alloggiamento batterie



6. Supporto con filettatura 1/4 - 20

## Cavalletto

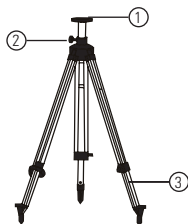

1. Innesto a vite 1/4 - 20
2. Colonna elevatrice
3. Gambe regolabili

## Supporto a L

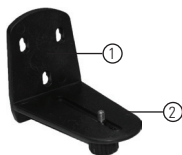

1. Fessure a occhiello
2. Innesto a vite 1/4 - 20

## Morsetto dell'asta

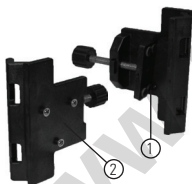

1. Morsetto
2. Chiave con 3 pioli



Precisione livellamento:	≤ 4 mm / 10 m (≤ 5/32 in / 30 ft)
Precisione orizzontale/verticale	≤ 4 mm / 10 m (≤ 5/32 in / 30 ft)
Intervallo di esercizio:	Autolivellamento a ±4°
Distanza di esercizio:	≤ 10 m (≤ 30 ft)
Classe laser:	Classe 1
Lunghezza d'onda laser:	635 nm ± 5 nm
Tempo di esercizio:	16 ore
Tensione di alimentazione:	4,5 V
Alimentazione:	3 batterie AA (alcaline)
Classe di protezione IP:	IP54
Intervallo temperatura di esercizio:	da -10° C a +40° C (da +14° F a +104° F)
Intervallo temperatura di conservazione:	da -20° C a +60° C (da -4° F a +140° F)
Peso (senza base né batterie):	230 g (8 oz)
Dimensioni:	88 mm × 48 mm × 90 mm (3 1/2 in × 1 7/8 in × 3 1/2 in)





## Installazione/rimozione delle batterie

1. Girare l'unità laser verso la parte posteriore. Aprire il coperchio dell'alloggiamento batterie curvando la linguetta verso l'esterno per aprirla.
2. Installare/rimuovere le batterie. Inserire le batterie nel verso giusto quando vengono posizionate nell'unità laser.
3. Chiudere il coperchio dell'alloggiamento batterie. Assicurarsi che la linguetta scatti nuovamente in posizione di chiusura.



## Unità laser

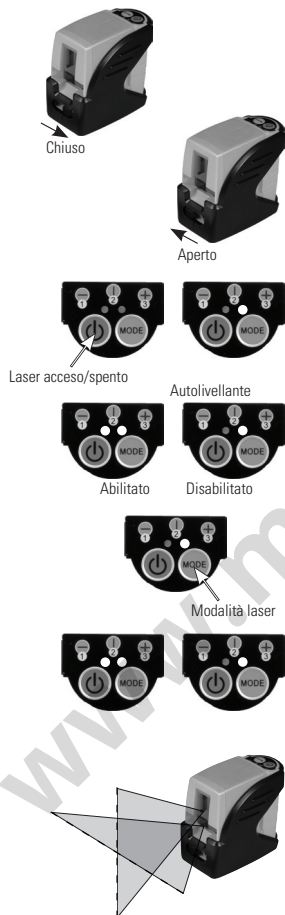

1. Il bloccaggio per il trasporto è in posizione di chiusura.  
La funzione di autolivellamento è disabilitata.
2. Il bloccaggio per il trasporto è in posizione di apertura.  
La funzione di autolivellamento è abilitata.
3. Premere il tasto di accensione per accendere/spengere il laser. Il LED destro si illumina con una luce verde quando il laser è acceso.
4. Il LED sinistro si illumina con una luce blu quando il laser è acceso con la funzione di autolivellamento disabilitata. Il LED è spento quando la funzione di autolivellamento è abilitata.
5. Premere il tasto di modalità laser per passare da una modalità laser all'altra - solo orizzontale, solo verticale, orizzontale e verticale.
6. I tasti di accensione e modalità laser sono sempre funzionanti. Possono essere utilizzati quando la funzione di autolivellamento è abilitata o disabilitata.
7. Il/i raggio/i laser lampeggia/no per indicare che l'unità laser si trova al di fuori dei valori compresi nell'intervallo di esercizio. Riposizionare l'unità laser per correggere il livellamento.



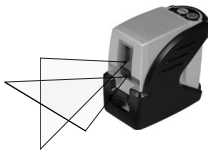

- Il/i raggio/i laser sarà/anno più tenue/i quando le batterie stanno per scaricarsi. Sostituire le batterie.

## Cavalletto

---



- Innesto a vite 1/4 - 20 per fissare l'unità laser.



- Pieghevole per rendere facile il trasporto.

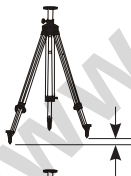

- Le gambe sono regolabili per terreni irregolari.



- Colonna elevatrice regolabile per diverse altezze.



## Supporto a L e morsetto dell'asta

---



1. Innesto a vite 1/4 - 20 per fissare l'unità laser. Permette il completo posizionamento a 360° dell'unità laser.



2. Fissare il morsetto dell'asta al supporto a L per consentire l'uso del cavalletto o di altri accessori opzionali.



## Applicazioni

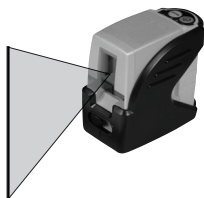

1. **A piombo:**  
Usando il raggio laser verticale, fissare un piano di riferimento verticale. Posizionare il/gli oggetto/i desiderato/i finché non è/sono allineato/i con il piano di riferimento verticale per assicurarsi che il/gli oggetto/i sia/no a piombo.

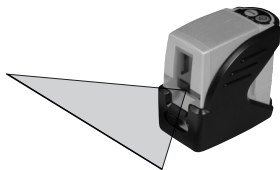

2. **A livello:**  
Usando il raggio laser orizzontale, fissare un piano di riferimento orizzontale. Posizionare il/gli oggetto/i desiderato/i finché non è/sono allineato/i con il piano di riferimento orizzontale per assicurarsi che il/gli oggetto/i sia/no a livello.

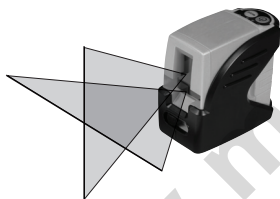

3. **Squadro:**  
Usando sia il raggio laser verticale sia quello orizzontale, fissare un punto in cui il raggio verticale e quello orizzontale si intersecano. Posizionare il/gli oggetto/i desiderato/i finché non è/sono allineato/i sia con il raggio laser verticale sia con quello orizzontale per assicurarsi che il/gli oggetto/i sia/no a squadra.

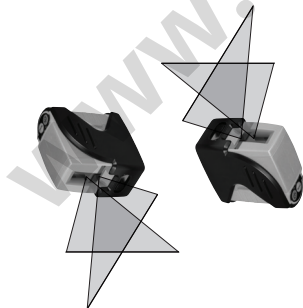

4. **Autolivellamento disabilitato:**  
Disabilitare la funzione di autolivellamento permette all'unità laser di proiettare un raggio laser rigido in qualsiasi direzione.





**NOTA:** l'unità laser è stata calibrata al momento della fabbricazione. Controllare periodicamente la precisione dell'unità laser per assicurarsi che siano mantenuti i valori secondo i quali è stata calibrata.

## Precisione del raggio di livello

1. Posizionare l'unità laser come mostrato con il laser acceso. Segnare il punto  $P_1$  nell'intersezione.

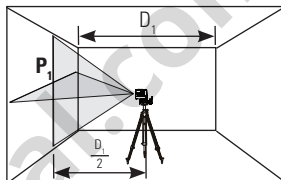

2. Ruotare l'unità laser di 180° e segnare il punto  $P_2$  nell'intersezione.

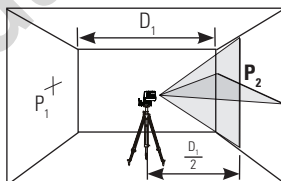

3. Spostare l'unità laser vicino al muro e segnare il punto  $P_3$  nell'intersezione.

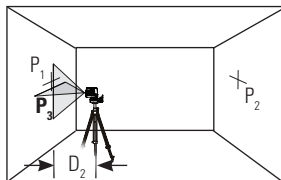

4. Ruotare l'unità laser di 180° e segnare il punto  $P_4$  nell'intersezione.

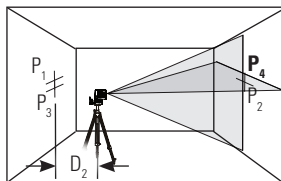

5. Misurare la distanza verticale dal pavimento fino ad ogni punto. Calcolare la differenza tra le distanze  $D_{P_1}$  e  $D_{P_3}$  per ottenere  $D_3$  e le distanze  $D_{P_2}$  e  $D_{P_4}$  per ottenere  $D_4$ .

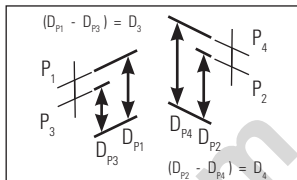

6. Calcolare la distanza di scostamento massima e confrontare la differenza di  $D_3$  e  $D_4$  come mostrato nell'equazione. Se la somma non è minore o uguale alla distanza di scostamento massima calcolata, l'unità deve essere restituita al distributore Stanley.

Distanza di scostamento massima:

$$\begin{aligned} &= 0,4 \frac{\text{mm}}{\text{m}} \times (D_1 \text{ m} - (2 \times D_2 \text{ m})) \\ \text{Max} &= 0,0048 \frac{\text{in}}{\text{ft}} \times (D_1 \text{ ft} - (2 \times D_2 \text{ ft})) \end{aligned}$$

Confrontare:

$$D_3 - D_4 \leq \pm \text{Max}$$

Esempio:  $D_1 = 10 \text{ m}$ ,  $D_2 = 0,5 \text{ m}$

$$D_{P_1} = 30,75 \text{ mm}, D_{P_2} = 29 \text{ mm}, D_{P_3} = 30 \text{ mm}, D_{P_4} = 29,75 \text{ mm}$$

$$D_3 = (30,75 \text{ mm} - 30 \text{ mm}) = 0,75 \text{ mm}$$

$$D_4 = (29 \text{ mm} - 29,75 \text{ mm}) = -0,75 \text{ mm}$$

$$0,4 \frac{\text{mm}}{\text{m}} \times (10 \text{ m} - (2 \times 0,5 \text{ m})) = 3,6 \text{ mm} \text{ (distanza di scostamento massima)}$$

$$(0,75 \text{ mm}) - (-0,75 \text{ mm}) = 1,5 \text{ mm}$$

$1,5 \text{ mm} \leq 3,6 \text{ mm}$  (**CORRETTO**, i valori dell'unità sono compresi tra quelli della calibrazione)

## Precisione del raggio orizzontale

1. Posizionare l'unità laser come mostrato con il laser acceso. Puntare il raggio verticale verso il primo angolo o punto di riferimento. Misurare metà della distanza  $D_1$  e segnare il punto  $P_1$ .

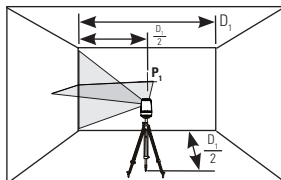

2. Ruotare l'unità laser verso l'altro angolo o punto di riferimento.

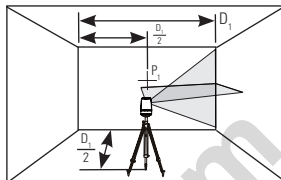

3. Misurare la distanza verticale tra  $P_1$  e il raggio orizzontale dalla seconda posizione.

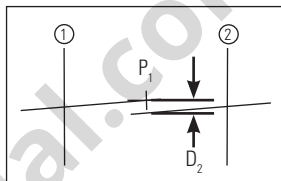

4. Calcolare la distanza di scostamento massima e confrontarla con  $D_2$ . Se  $D_2$  non è minore o uguale alla distanza di scostamento massima calcolata, l'unità deve essere restituita al distributore Stanley.

Distanza di scostamento massima:

$$\begin{aligned} \text{Max} &= 0,4 \frac{\text{mm}}{\text{m}} \times D_1, \text{m} \\ &= 0,0048 \frac{\text{in}}{\text{ft}} \times D_1, \text{ft} \end{aligned}$$

Confrontare:

$$D_2 \leq \text{Max}$$

Esempio:  $D_1 = 5 \text{ m}$ ,  $D_2 = 1 \text{ mm}$

$$0,4 \frac{\text{mm}}{\text{m}} \times 5 \text{ m} = 2 \text{ mm} \text{ (distanza di scostamento massima)}$$

$1 \text{ mm} \leq 2 \text{ mm}$  (**CORRETTO**, i valori dell'unità sono compresi tra quelli della calibrazione)





## Precisione del raggio verticale

1. Misurare l'altezza dello stipite di una porta o un punto di riferimento per ottenere la distanza  $D_1$ . Posizionare l'unità laser come mostrato con il laser acceso. Puntare il raggio verticale verso lo stipite della porta o il punto di riferimento. Segnare i punti  $P_1$ ,  $P_2$  e  $P_3$  come mostrato.

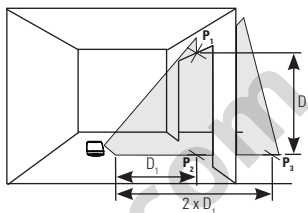

2. Spostare l'unità laser verso il lato opposto dello stipite della porta o del punto di riferimento e allineare il raggio verticale con  $P_2$  e  $P_3$ .

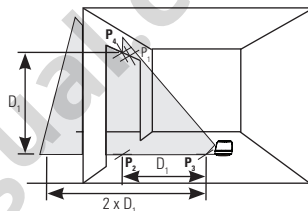

3. Misurare le distanze orizzontali tra  $P_1$  e il raggio verticale dalla seconda posizione.

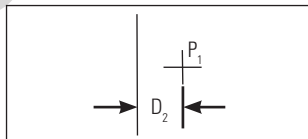

4. Calcolare la distanza di scostamento massima e confrontarla con  $D_2$ . Se  $D_2$  non è minore o uguale alla distanza di scostamento massima calcolata, l'unità deve essere restituita al distributore Stanley.

Distanza di scostamento massima:

$$\begin{aligned} &= 0,8 \frac{\text{mm}}{\text{m}} \times D_1, \text{ m} \\ \text{Max} &= 0,0096 \frac{\text{in}}{\text{ft}} \times D_1, \text{ ft} \end{aligned}$$

Confrontare:

$$D_2 \leq \text{Max}$$

Esempio:  $D_1 = 2 \text{ m}$ ,  $D_2 = 0,5 \text{ mm}$

$0,8 \frac{\text{mm}}{\text{m}} \times 2 \text{ m} = 1,6 \text{ mm}$  (distanza di scostamento massima)

$0,5 \text{ mm} \leq 1,6 \text{ mm}$  (**CORRETTO**, i valori dell'unità sono compresi tra quelli della calibrazione)



L'unità laser non è resistente all'acqua. **NON** far penetrare acqua all'interno dell'unità. Ciò può causare danni ai circuiti interni.

**NON** esporre l'unità laser alla luce diretta del sole o ad alte temperature. La parte esterna e alcune parti interne sono di plastica e possono deformarsi ad alte temperature.

**NON** riporre l'unità laser in ambienti freddi. Può formarsi dell'umidità nelle parti interne quando iniziano a riscaldarsi. Questa umidità potrebbe appannare le finestre e causare la corrosione dei circuiti.

Quando l'unità viene utilizzata in ambienti polverosi, si può accumulare dello sporco sulla finestra del laser. Rimuovere qualsiasi tipo di umidità o sporco con un panno morbido e asciutto.

**NON** usare agenti pulenti o solventi aggressivi.

Riporre l'unità laser nella valigetta quando non viene utilizzata. Se lo strumento viene conservato per un lungo periodo, per evitare possibili danni, rimuovere le batterie prima di riporlo.





## Garanzia di un anno

Stanley Tools offre una garanzia di un anno dalla data di acquisto sui propri strumenti elettronici di misurazione per quanto riguarda difetti nei materiali e/o nella lavorazione.

I prodotti difettosi saranno riparati o sostituiti a discrezione di Stanley Tools, se inviati accompagnati dalla prova di acquisto a:

Stanley Tools srl  
Via Don L.Meroni, 56  
22060 FIGINO SERENZA (Co)  
Italy

La garanzia non copre difetti causati da danni accidentali, logorio, uso differente da quello indicato nelle istruzioni del produttore, o riparazioni o modifiche eseguite da personale non autorizzato da Stanley Tools.

Riparazioni o sostituzioni effettuate in garanzia non hanno alcuna influenza sulla data di scadenza della garanzia stessa.

Laddove consentito dalla legge, Stanley Tools declina ogni responsabilità per danni accidentali o indiretti causati da difetti di questo prodotto.

È vietata qualsiasi modifica a questa garanzia senza l'autorizzazione di Stanley Tools.

La presente garanzia non pregiudica i diritti legali degli acquirenti del prodotto.

Questa garanzia è soggetta alla legislazione inglese; Stanley Tools e l'acquirente accettano in maniera irrevocabile di rimettersi alla giurisdizione esclusiva dei tribunali inglesi, in caso di rivendicazioni o questioni relative alla presente.

**NOTA IMPORTANTE:** l'utente è responsabile del corretto uso e della manutenzione dello strumento. Inoltre, l'utente è completamente responsabile del controllo periodico e della precisione dell'unità laser e dunque della calibrazione dello strumento.

La calibrazione e la cura dello strumento non sono comprese nella garanzia.

*Soggetto a modifica senza preavviso*



## Contenido

1. Seguridad
2. Descripción del producto
3. Especificaciones
4. Instrucciones de funcionamiento
5. Calibración
6. Mantenimiento y cuidados
7. Garantía

## Seguridad



### Seguridad del usuario

Lea atentamente las Instrucciones de seguridad y el Manual del usuario antes de utilizar este producto. La persona responsable del instrumento deberá garantizar que todos los usuarios entiendan y sigan estas instrucciones.

Guarde este manual para consultarlo en el futuro.

**IMPORTANTE:** La herramienta láser incluye las siguientes etiquetas para su comodidad y seguridad. En ellas se indica el lugar del nivel por donde se emite el haz láser. **NO OLVIDE NUNCA** su ubicación al utilizar el nivel.



EN 60825-1

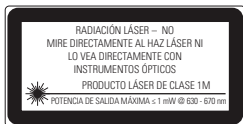

**NO** retire ninguna de las pegatinas de advertencia de la carcasa. Este instrumento únicamente debe usarse para las tareas de nivelación y diseño, como se describe en este manual.

Asegúrese **SIEMPRE** de que las personas que se encuentren dentro del radio de alcance de la herramienta sean conscientes de los riesgos que supone mirar directamente al haz láser.

**NO** lo utilice en combinación con otros instrumentos ópticos. No modifique el instrumento, ni lo manipule o lo emplee para otros usos distintos de los descritos en este manual.

**NO** mire el haz con instrumentos ópticos como amplificadores, binoculares o telescopios.

**NO** mire directamente el haz láser o lo dirija hacia otras personas. Asegúrese de no fijar el instrumento a la altura de los ojos. La protección ocular suele alcanzarse mediante respuestas naturales de aversión, como el reflejo del parpadeo.

**NO** dirija el haz del láser hacia otras personas.

**Desconecte SIEMPRE** la herramienta láser cuando no la esté utilizando. Si la deja conectada, aumentará el riesgo de que alguien mire de forma involuntaria al haz láser.

**NO** utilice la herramienta láser en zonas de combustible, es decir, en presencia de líquidos, gases o polvo inflamables.

**NO** desmonte la herramienta láser. No contiene piezas que puedan ser reparadas por el usuario. Si lo hace, se anulará la garantía del producto. No modifique el producto de ninguna manera. Esto podría dar como resultado una exposición peligrosa a la radiación.

**NO** use este instrumento en zonas donde haya riesgo de explosión.

**NOTA:** Dado que el haz del láser es de tipo focalizado, asegúrese de comprobar el recorrido del haz en una distancia relativamente larga y tome todas las medidas necesarias para garantizar que no interfiera con otras personas.



## Seguridad de las pilas

---

**ADVERTENCIA:** las pilas pueden explotar o tener fugas y causar lesiones graves o un incendio. Para reducir este riesgo:

**Siga SIEMPRE** todas las instrucciones y advertencias que figuran en la etiqueta y en el embalaje de las pilas.

**NO** cortocircuite los terminales de las pilas

**NO** recargue las pilas alcalinas.

**NO** mezcle pilas nuevas y viejas. Sustitúyalas todas al mismo tiempo por unas nuevas de la misma marca y tipo.

**NO** mezcle pilas de distintos tipos.

**NO** arroje las pilas al fuego.

**Mantenga SIEMPRE** las pilas lejos del alcance de los niños.

Retire SIEMPRE las pilas si no va a utilizar el dispositivo durante varios meses.

**NOTA:** Asegúrese de usar las pilas recomendadas.

**NOTA:** Asegúrese de insertar las pilas de la manera adecuada, con la polaridad correcta.

## Vida útil

---

**NO** se deshaga de este producto junto con la basura doméstica.

**DESHÁGASE de las pilas de acuerdo con la normativa local.**



**RECICLE** siguiendo la normativa local para la recogida y eliminación de residuos eléctricos y electrónicos emanada de la Directiva WEEE.

## Declaración de conformidad

---

Stanley Works declara que la marca CE se ha aplicado a este producto, con arreglo a la directiva sobre marcado CE 93/68/EEC.

Este producto cumple la norma EN60825-1:2007.

Para obtener más información, consulte [www.stanleyworks.com](http://www.stanleyworks.com).



EN 60825-1

CE



Cumple con  
ROHS

## Descripción del producto

---



### Contenido del embalaje

---

1. Unidad láser
2. Trípode
3. Soporte tipo L
4. Abrazadera (se acopla al soporte tipo L)
5. Objetivo láser
6. Maletín de transporte
7. Pilas (3 unidades AA)
8. Manual del usuario



## Resumen del producto

---

### Unidad láser



1. Ventana del láser en cruz
2. Bloqueo de transporte



3. Teclado
4. Etiqueta de advertencia para el láser
5. Tapa del compartimento para pilas



6. Roscas de instalación de 1/4 - 20 hilos





## Trípode

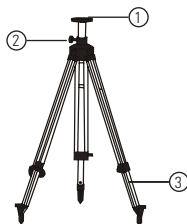

1. Montura roscada 1/4 - 20
2. Columna elevadora
3. Patas ajustables

## Soporte tipo L

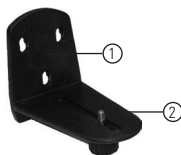

1. Ranuras de ojo de cerradura
2. Montura roscada de - 20

## Abrazadera

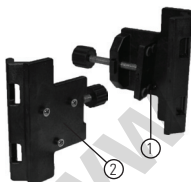

1. Pinza
2. Tecla de 3 clavijas





Precisión de la nivelación:	≤ 4 mm. / 10 m. (≤ 5/81,28 cm. / 914,40 cm.)
Precisión horizontal / vertical	≤ 4 mm. / 10 m. (≤ 5/81,28 cm. / 914,40 cm.)
Distancia operativa:	Autonivelación ±4°
Distancia de trabajo:	≤ 10 m. (≤ 30 ft)
Clase de láser:	Clase 1
Longitud de onda del láser:	635 nm. ± 5 nm.
Tiempo de funcionamiento:	16 h
Tensión de alimentación:	4,5 V
Alimentación:	3 pilas AA (alcalinas)
Grado IP:	IP54
Rango de temperatura de funcionamiento:	-10 °C a +40 °C (+14 °F a +104 °F)
Rango de temperatura de almacenamiento:	-20 °C a +60 °C (-4 °F a +140 °F)
Peso (sin la base ni las pilas):	230 g. (226,80 g)
Dimensiones:	88 mm. × 48 mm. × 90 mm (3 1/2 in × 1 7/8 in × 3 1/2 in)



## Instalación/ extracción de las pilas

1. Gire la unidad láser hacia la parte trasera. Abra la tapa del compartimento de las pilas doblando la pestaña para desbloquearla.



2. Instalación/ extracción de las pilas. Oriente correctamente las pilas al introducirlas en la unidad láser.



3. Cierre y bloquee la tapa del compartimento de las pilas. Asegúrese de que la pestaña encaje en su posición de bloqueo.



## Unidad láser

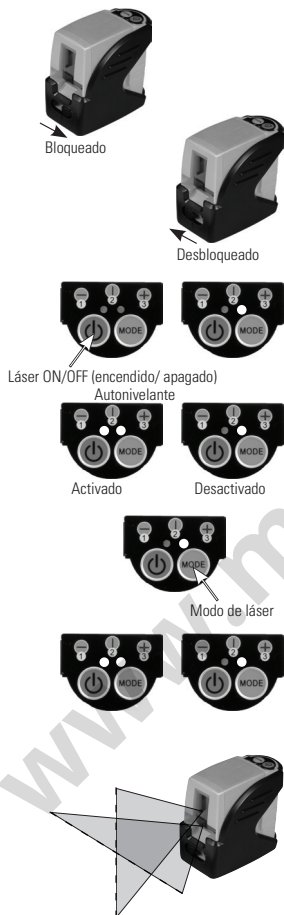

1. Bloqueo de transporte en posición bloqueada.  
La función de autonivelación está desactivada.
2. Bloqueo de transporte en posición desbloqueada.  
La función de autonivelación está activada.
3. Pulse la tecla de encendido para ENCEDER/APAGAR el láser. El indicador LED derecho se ilumina en verde cuando el láser está encendido.
4. El indicador LED izquierdo se ilumina en azul cuando el láser está encendido con la función de autonivelación desactivada. El LED se apaga cuando la función de autonivelación está activada.
5. Pulse la tecla de modo del láser para alternar entre los modos disponibles: solo horizontal, solo vertical, y horizontal y vertical.
6. Las teclas de encendido y de modo del láser permanecen siempre funcionales. Puede utilizarse cuando la función de autonivelación está activada o desactivada.
7. El haz o haces del láser parpadean para indicar que la unidad láser se encuentra fuera del rango de trabajo. Vuelva a colocar la unidad láser en una superficie más plana.

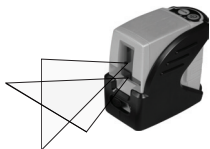

8. El haz o haces láser se atenuarán cuando la carga de la batería esté baja. Sustituya las pilas.

## Trípode

---



1. Roscas de instalación de 1/4 - 20 hilos para acoplar la unidad láser.



2. Plegable para facilitar el transporte.

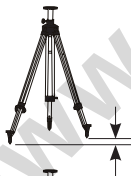

3. Las patas son ajustables para adaptarse a suelos no nivelados.



4. Columna elevadora ajustable a distintas alturas.



## Soporte de tipo L y abrazadera

---



1. Roscas de instalación de 1/4 - 20 hilos para acoplar la unidad láser. Permite una colocación de la unidad láser a 360°.



2. Ajuste la abrazadera al soporte de tipo L para poder usarlo con un trípode u otros accesorios opcionales.



## Aplicaciones

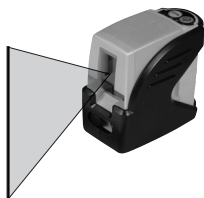

1. **Plomada:**  
con ayuda del haz láser vertical, establezca un plano vertical de referencia. Coloque el objeto u objetos hasta que se encuentren alineados con el plano vertical de referencia para garantizar la plomada del objeto u objetos.

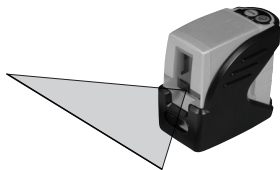

2. **Nivel:**  
con ayuda del haz láser horizontal, establezca un plano horizontal de referencia. Coloque el objeto u objetos hasta que se encuentren alineados con el plano horizontal de referencia para garantizar el nivel del objeto u objetos.

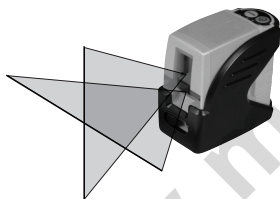

3. **Escuadra:**  
usando los haces de láser vertical y horizontal, establezca el punto en el que se crucen dichos haces. Coloque el objeto u objetos hasta que se encuentren alineados con los haces láser vertical y horizontal para garantizar que los objetos queden cuadrados.

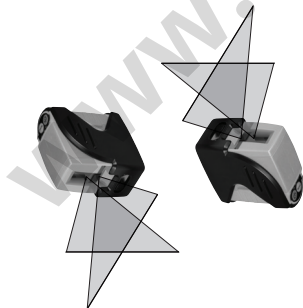

4. **Autonivelación desactivada:**  
desactivar la función de autonivelación permite que la unidad láser proyecte un haz láser rígido en cualquier dirección.





**NOTA:** La unidad láser ha sido calibrada en fábrica. Compruebe periódicamente la precisión de la unidad láser para estar seguro de que las especificaciones de calibración se mantienen.

## Precisión del haz láser

1. Coloque la unidad láser como se muestra con el láser ENCENDIDO. Marque el punto  $P_1$  en cruz.

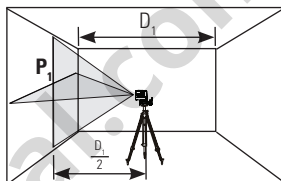

2. Gire la unidad láser  $180^\circ$  y marque el punto  $P_2$  en cruz.

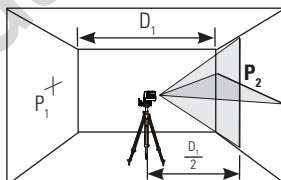

3. Acerque la unidad láser a la pared y marque el punto  $P_3$  en cruz.

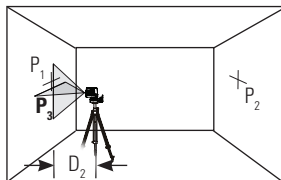

4. Gire la unidad láser  $180^\circ$  y marque el punto  $P_4$  en cruz.

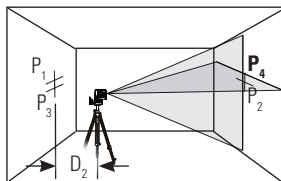



5. Mida la distancia vertical desde el suelo a cada punto. Calcule la diferencia entre las distancias  $P_{P_1}$  y  $P_{P_3}$  para obtener  $D_3$  y las distancias  $D_{P_2}$  y  $D_{P_4}$  para obtener  $D_4$ .

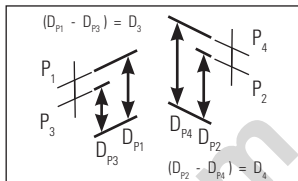

6. Calcule la distancia máxima de desviación admisible y compárela con la diferencia de  $D_3$  y  $D_4$  como se muestra en la ecuación. Si la suma no es inferior o igual a la distancia máxima de desviación calculada, la unidad deberá ser devuelta al distribuidor Stanley.

Distancia máxima de desviación:

$$= 0,4 \frac{\text{mm}}{\text{m}} \times (D_1 \text{ m.} - (2 \times D_2 \text{ m.}))$$

$$\text{Máx.} = 0,0048 \frac{\text{in}}{\text{ft}} \times (D_1 \text{ ft} - (2 \times D_2 \text{ ft}))$$

Comparar:

$$D_3 - D_4 \leq \pm \text{Máx.}$$

Ejemplo:  $D_1 = 10 \text{ m.}$ ,  $D_2 = 0,5 \text{ m.}$

$$D_{P_1} = 30,75 \text{ mm.}, D_{P_2} = 29 \text{ mm.}, D_{P_3} = 30 \text{ mm.}, D_{P_4} = 29,75 \text{ mm.}$$

$$D_3 = (30,75 \text{ mm.} - 30 \text{ mm.}) = 0,75 \text{ mm.}$$

$$D_4 = (29 \text{ mm.} - 29,75 \text{ mm.}) = -0,75 \text{ mm.}$$

$$0,4 \frac{\text{mm}}{\text{m}} \times (10 \text{ m.} - (2 \times 0,5 \text{ m.})) = 3,6 \text{ mm. (distancia de desviación máxima permisible)}$$

$$(0,75 \text{ mm.}) - (-0,75 \text{ mm.}) = 1,5 \text{ mm.}$$

$$1,5 \text{ mm.} \leq 3,6 \text{ mm. (VERDADERO, la unidad está calibrada)}$$

## Precisión del láser horizontal

1. Coloque la unidad láser como se muestra con el láser ENCENDIDO. Dirija el haz vertical a la primera esquina o punto de referencia. Mida la mitad de la distancia  $D_1$  y marque el punto  $P_1$ .

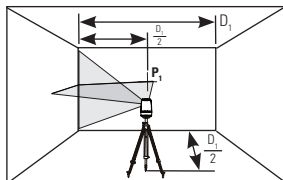

2. Gire la unidad láser a otra esquina o punto de referencia.

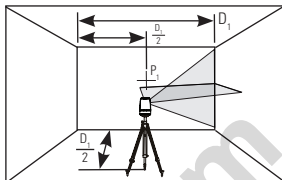

3. Mida las distancias verticales entre  $P_1$  y el haz horizontal desde la 2ª ubicación.

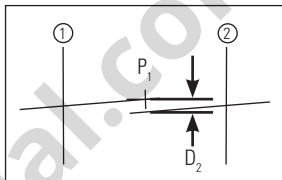

4. Calcule la distancia máxima de desviación admisible y compárela con  $D_2$ . Si  $D_2$  no es inferior o igual a la distancia máxima de desviación calculada, la unidad deberá ser devuelta al distribuidor Stanley.

Distancia máxima de desviación:

$$\begin{aligned} \text{Máx.} &= 0,4 \frac{\text{mm}}{\text{m}} \times D_1, \text{m.} \\ &= 0,0048 \frac{\text{in}}{\text{ft}} \times D_1, \text{ft} \end{aligned}$$

Comparar:

$$D_2 \leq \text{Máx.}$$

Ejemplo:  $D_1 = 5 \text{ m.}$ ,  $D_2 = 1 \text{ mm.}$

$$0,4 \frac{\text{mm}}{\text{m}} \times 5 \text{ m.} = 2 \text{ mm. (distancia de desviación máxima permisible)}$$

$$1 \text{ mm.} \leq 2 \text{ mm. (VERDADERO, unidad calibrada)}$$



## Precisión del haz vertical

1. Mida la altura de un marco de puerta o punto de referencia para obtener la distancia  $D_1$ . Coloque la unidad láser como se muestra con el láser ENCENDIDO. Dirija el haz vertical al marco de la puerta o punto de referencia. Marque los puntos  $P_1$ ,  $P_2$  y  $P_3$  como se muestra.

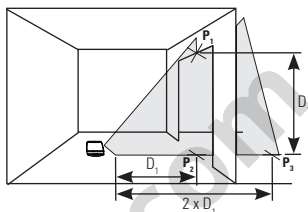

2. Desplace la unidad láser al lado opuesto del marco de la puerta o punto de referencia y alinee el haz vertical con  $P_2$  y  $P_3$ .

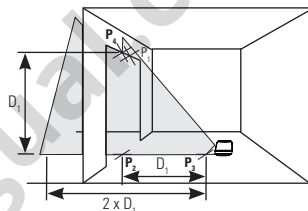

3. Mida las distancias horizontales entre  $P_1$  y el haz vertical desde la 2ª ubicación.

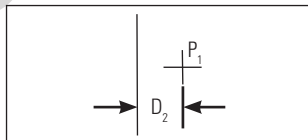

4. Calcule la distancia máxima de desviación admisible y compárela con  $D_2$ . Si  $D_2$  no es inferior o igual a la distancia máxima de desviación calculada, la unidad deberá ser devuelta al distribuidor Stanley.

### Distancia máxima de desviación:

$$= 0,8 \frac{\text{mm}}{\text{m}} \times D_1, \text{ m.}$$

$$\text{Máx.} = 0,0096 \frac{\text{in}}{\text{ft}} \times D_1, \text{ ft}$$

### Comparar:

$$D_2 \leq \text{Máx.}$$

Ejemplo:  $D_1 = 2 \text{ m.}$ ,  $D_2 = 0,5 \text{ mm.}$

$0,8 \frac{\text{mm}}{\text{m}} \times 2 \text{ m.} = 1,6 \text{ mm.}$  (distancia de desviación máxima permisible)

$0,5 \text{ mm.} \leq 1,6 \text{ mm.}$  (**VERDADERO**, unidad calibrada)





La unidad láser no es estanca. **NO** permita que se moje. Podrían dañarse los circuitos internos.

**NO** exponga la unidad a la luz solar directa ni a temperaturas altas. La carcasa y algunas piezas internas están fabricadas en plástico y podrían deformarse si se exponen a temperaturas altas.

**NO** almacene la unidad láser en un lugar frío. Si lo hace, podría producirse condensación en las piezas internas al encenderlo. La humedad podría empañar las ventanas del láser y corroer las placas de los circuitos internos.

Cuando trabaje en lugares polvorientos, es posible que se deposite polvo en la ventana de salida del láser. Utilice un paño suave y seco para quitar el polvo o la humedad.

**NO** utilice productos de limpieza agresivos ni disolventes.

Guarde la unidad láser en su maletín cuando no la vaya a usar. Si la va a almacenar durante un periodo de tiempo prolongado, extraiga las pilas para evitar posibles daños en el instrumento.





## Un año de garantía

Stanley Tools garantiza sus herramientas electrónicas de medición contra defectos de material o fabricación durante un año desde su fecha de compra.

Los productos que presenten defectos deberán ser enviados a Stanley a la dirección indicada a continuación junto con un justificante de compra. Stanley procederá a su reparación o sustitución según lo estime conveniente.

STANLEY IBERIA, S.L.  
Via Auguats 13 – 15 despacho 506  
08006 Barcelona  
SPAIN

Esta garantía no cubre defectos causados por daños fortuitos, desgaste y uso natural del producto, ni por daños que resulten de una utilización diferente a la indicada en las instrucciones del fabricante, o que se deban a reparaciones o modificaciones efectuadas en el producto y que no hayan sido autorizadas por Stanley Tools.

La reparación o cambio según esta garantía no afectará la fecha de caducidad de la misma.

Según la ley, Stanley Tools no será responsable según esta garantía de ninguna pérdida indirecta o como consecuencia de los defectos del producto.

Esta garantía no puede ser modificada sin la autorización de Stanley Tools.

Esta garantía no afecta a los derechos legales del consumidor que adquiere el producto.

Esta garantía se rige según la ley inglesa y Stanley Tools y el comprador confirman irrevocablemente estar de acuerdo en que dicha garantía sea tratada según la legislación y juzgados de Inglaterra para cualquier disputa que pudiera surgir en relación a la misma.

**NOTA IMPORTANTE:** El cliente se hace responsable de la utilización y mantenimiento correctos de la herramienta. Además, el cliente será íntegramente responsable de la comprobación periódica de la unidad láser y, por consiguiente, de la calibración del instrumento.

La calibración y el cuidado no están cubiertos por la garantía.

*Sujeto a cambios sin previo aviso*



## Índice

1. Segurança
2. Descrição do produto
3. Especificações
4. Instruções de funcionamento
5. Calibração
6. Manutenção e cuidados
7. Garantia

## Segurança

### Segurança do utilizador

Leia atentamente as Instruções de segurança e o Manual do utilizador antes de utilizar este produto. A pessoa responsável pelo instrumento deve assegurar que todos os utilizadores compreendem e cumprem estas instruções.

Guarde este manual para futura referência.

**IMPORTANTE:** Os rótulos abaixo estão na sua ferramenta de laser para sua conveniência e segurança. Indicam o local onde o raio laser é emitido pelo nível. Assegure-se de que **CONHECE SEMPRE** a sua localização quando estiver a utilizar o nível.



EN 60825-1

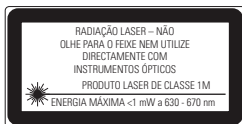

**NÃO** remova nenhum rótulo de aviso da estrutura. Este instrumento deve ser utilizado apenas para tarefas de nivelamento e traçados, conforme indicado neste manual.

**DEVE SEMPRE** assegurar-se de que as pessoas presentes nas proximidades estão cientes do perigo de olhar directamente para a ferramenta de laser.

**NÃO** utilize em combinação com outros instrumentos ópticos. Não modifique o instrumento, não faça manipulações nem utilize noutras aplicações para além das descritas no manual.

**NÃO** olhe para o raio com auxiliares ópticos, como lupas, binóculos ou telescópios.

**NÃO** olhe fixamente para o raio laser nem o direcione para outras pessoas. Certifique-se de que o instrumento não está configurado para o nível dos olhos. A protecção dos olhos é normalmente efectuada pelas respostas naturais à aversão, como o reflexo de piscar os olhos.

**NÃO** direcione o raio laser para outras pessoas.

**DEVE SEMPRE** desligar o instrumento de laser quando não estiver em utilização. Deixar o instrumento LIGADO aumenta o risco de alguém inadvertidamente olhar fixamente para o raio laser.

**NÃO** opere o laser em áreas combustíveis, como perto de líquidos inflamáveis, gases ou pó.

**NÃO** desmonte o instrumento de laser. Não há peças no interior que possam ser reparadas pelo utilizador. Desmontar o laser anulará qualquer garantia do produto. Não modifique o produto de forma alguma. Modificar o instrumento de laser pode resultar numa exposição perigosa a radiações.

**NÃO** utilize este instrumento em áreas em que o risco de explosão esteja presente.

**NOTA:** Uma vez que o raio laser é de foco, certifique-se de que verifica o trajecto do raio numa distância relativamente longa e toma todas as precauções necessárias para se certificar de que o raio não interfere com outras pessoas.



## Segurança das pilhas

---

**AVISO:** As pilhas podem rebentar ou babar e podem provocar ferimentos ou incêndio. Para reduzir este risco:

**DEVE SEMPRE** seguir todas as instruções e avisos no rótulo e na embalagem das pilhas.

**NÃO** provoque um curto-circuito nos terminais das pilhas

**NÃO** carregue pilhas alcalinas.

**NÃO** misture pilhas velhas com novas. Troque as pilhas todas na mesma altura por pilhas novas, da mesma marca e tipo.

**NÃO** misture tipos de pilhas.

**NÃO** coloque as pilhas no fogo.

**MANTENHA** as pilhas fora do alcance das crianças.

**RETIRE** as pilhas se o dispositivo não for utilizado durante vários meses.

**NOTA:** Verifique se foram utilizadas as pilhas correctas, conforme recomendado.

**NOTA:** Verifique se as pilhas foram inseridas da forma correcta, com a polaridade correcta.

## Fim de vida

---

**NÃO** elimine este produto com o lixo doméstico.

**Elimine SEMPRE** as pilhas de acordo com as normas locais.



**RECYCLE** de acordo com as disposições locais para a recolha e eliminação de resíduos eléctricos e electrónicos, de acordo com a Directiva WEEE.





## Declaração de conformidade

---

A Stanley Works declara que a marca CE foi aplicada neste produto de acordo com a Directiva de Marcação CE 93/68/EEC.

Este produto encontra-se em conformidade com EN60825-1:2007.

Para informações adicionais, por favor consulte [www.stanleyworks.com](http://www.stanleyworks.com).



EN 60825-1



Em conformidade com  
ROHS

## Descrição do produto

---



### Conteúdo da embalagem

---

1. Unidade de laser
2. Tripé
3. Suporte em L
4. Pólo do fixador (fixa-se ao suporte em L)
5. Designador laser
6. Estojo
7. Pilhas (3 x AA)
8. Manual do utilizador



## Descrição geral do produto

---

### Unidade de laser



1. Janela para o cruzamento laser
2. Travão de transporte



3. Teclado
4. Rótulo de aviso do laser
5. Tapa do compartimento das pilhas



6. Rosca de 1/4 - 20

## Tripé

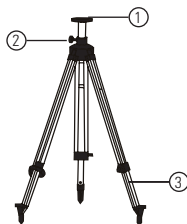

1. Parafuso de montagem de 1/4 - 20
2. Coluna do elevador
3. Pernas ajustáveis

## Suporte em L

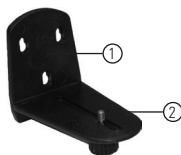

1. Ranhuras
2. Parafuso de montagem de 1/4 - 20

## Pólo do fixador

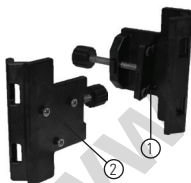

1. Fixador
2. Cavilha de 3 pinos



Precisão do nivelamento:	$\leq 4 \text{ mm} / 10 \text{ m}$ ( $\leq 5/32 \text{ pol.} / 30 \text{ pés}$ )
Precisão horizontal / vertical	$\leq 4 \text{ mm} / 10 \text{ m}$ ( $\leq 5/32 \text{ pol.} / 30 \text{ pés}$ )
Alcance:	Auto-calibragem até $\pm 4^\circ$
Distância de trabalho:	$\leq 10 \text{ m}$ ( $\leq 30 \text{ pés}$ )
Classe do laser:	Classe 1
Comprimento de onda do laser:	$635 \text{ nm} \pm 5 \text{ nm}$
Tempo de funcionamento:	16 h
Tensão:	4,5 V
Alimentação:	3 x pilhas AA (alcalinas)
Classificação IP:	IP54
Alcance da temperatura de funcionamento:	$-10^\circ \text{ C a } +40^\circ \text{ C}$ ( $+14^\circ \text{ F a } +104^\circ \text{ F}$ )
Alcance da temperatura de armazenamento:	$-20^\circ \text{ C a } +60^\circ \text{ C}$ ( $-4^\circ \text{ F a } +140^\circ \text{ F}$ )
Peso (sem base nem pilhas):	230 g (8 onças)
Tamanho:	$88 \text{ mm} \times 48 \text{ mm} \times 90 \text{ mm}$ ( $3 \frac{1}{2} \text{ pol.} \times 1 \frac{7}{8} \text{ pol.} \times 3 \frac{1}{2} \text{ pol.}$ )



## Instalação / remoção das Pilhas

1. Rode a traseira da unidade de laser para cima. Abra a tampa do compartimento de pilhas, dobrando a lingueta para fora para desbloquear.

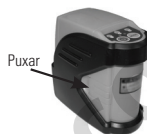

2. Instale / retire as pilhas. Coloque as pilhas correctamente na unidade de laser.



3. Feche e bloqueie a tampa do compartimento das pilhas. Certifique-se de que a lingueta ficou encaixada no sistema de bloqueio.



## Unidade de laser



Auto-nivelador



Desactivado

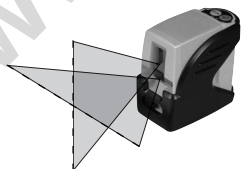

1. Travão de transporte na posição bloqueada.  
Função de auto-calibragem desactivada.
2. Travão de transporte na posição desbloqueada.  
Função de auto-calibragem activada.
3. Prima a tecla de energia para LIGAR / DESLIGAR o laser. O indicador LED passa a verde quando o laser está ligado.
4. O indicador LED passa a azul quando o laser está ligado com a função de auto-calibragem desactivada. O LED permanece desligado quando a função de auto-calibragem está activada.
5. Prima a tecla de modo laser para alternar entre os modos laser disponíveis - apenas horizontal, apenas vertical, horizontal e vertical.
6. As teclas de energia e modo laser estão sempre funcionais. Podem ser utilizadas com a função de auto-calibragem activada ou desactivada.
7. Os raios piscam para indicar que a unidade de laser está fora de alcance. Reposicione a unidade de laser de forma a ficar mais nivelada.

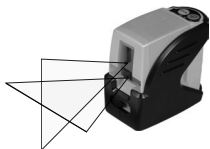

- Os raios laser ficam indistintos quando a bateria está fraca. Substitua as pilhas.

## Tripé

---



- Parafuso de montagem 1/4 - 20 para fixar a unidade de laser.



- Dobrável para transporte mais fácil.

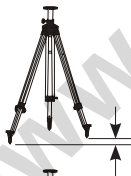

- As pernas são ajustáveis para terreno irregular.



- Coluna do elevador ajustável para diferentes alturas.

## Suporte em L e pólo do fixador

---



Posicionamento  
a 360°

1. Parafuso de montagem 1/4 - 20 para fixar a unidade de laser. Possibilita um posicionamento completo a 360° da unidade de laser.



2. Aperte o pólo do fixador a um suporte em L para possibilitar o uso com um tripé ou outros acessórios opcionais.



## Aplicações

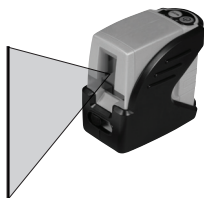

1. **Aprumar:**  
Utilizando o raio laser vertical, estabeleça um plano de referência vertical. Posicione o(s) objecto(s) desejados até ficarem alinhados com o plano de referência vertical para se certificar de que o(s) objecto(s) estão aprumados.

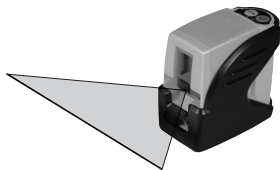

2. **Nível:**  
Utilizando o raio laser horizontal, estabeleça um plano de referência horizontal. Posicione o(s) objecto(s) desejados até ficarem alinhados com o plano de referência horizontal para se certificar de que o(s) objecto(s) estão nivelados.

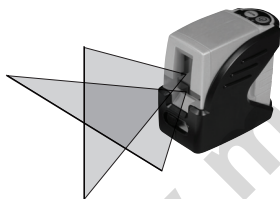

3. **Esquadria:**  
Utilizando quer o raio laser horizontal quer vertical, estabeleça o ponto em que os raios vertical e horizontal se cruzam. Posicione o(s) objecto(s) desejados até ficarem alinhados com o raio laser horizontal e vertical para se certificar de que o(s) objecto(s) estão em esquadria.

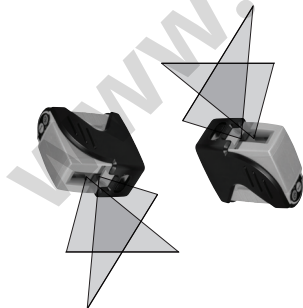

4. **Auto-calibragem desactivada:**  
A desactivação da função de auto-calibragem permite que a unidade de laser projecte um raio laser rígido em qualquer orientação.



**NOTA:** A unidade de laser foi calibrada no momento de fabrico. Verifique periodicamente a precisão da unidade de laser para se certificar de que as especificações se mantêm.

## Precisão do raio de nivelamento

1. Coloque a unidade de laser conforme demonstrado, com o laser ligado (ON). Marque o ponto  $P_1$  no cruzamento.

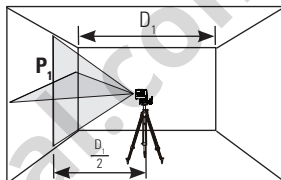

2. Rode a unidade de laser  $180^\circ$  e marque o ponto  $P_2$  no cruzamento.

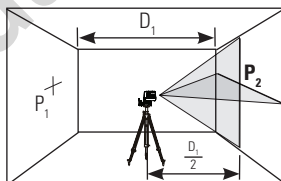

3. Aproxime a unidade de laser da parede e marque o ponto  $P_3$  no cruzamento.

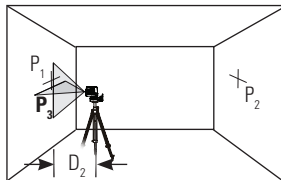

4. Rode a unidade de laser  $180^\circ$  e marque o ponto  $P_4$  no cruzamento.

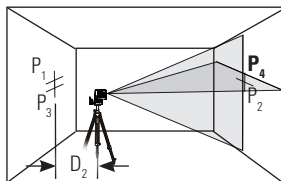

5. Meça a distância na vertical do chão a cada ponto. Calcule a diferença entre as distâncias  $D_{P_1}$  e  $D_{P_3}$  para obter  $D_3$  e entre as distâncias  $D_{P_2}$  e  $D_{P_4}$  para obter  $D_4$ .

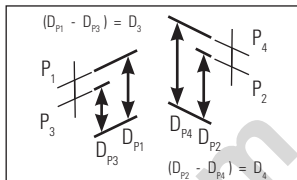

6. Calcule a distância de compensação máxima permitida e compare com a diferença de  $D_3$  e  $D_4$ , conforme demonstrado na equação. Se a soma não for igual ou inferior à distância de compensação máxima permitida, a unidade deve ser devolvida ao seu Distribuidor Stanley.

Distância máxima de compensação:

$$\begin{aligned} &= 0,4 \frac{\text{mm}}{\text{m}} \times (D_1 \text{ m} - (2 \times D_2 \text{ m})) \\ \text{Máx.} &= 0,0048 \frac{\text{pou}}{\text{pés}} \times (D_1 \text{ pés} - (2 \times D_2 \text{ pés})) \end{aligned}$$

Compare:

$$D_3 - D_4 \leq \pm \text{Máx.}$$

Exemplo:  $D_1 = 10 \text{ m}$ ,  $D_2 = 0,5 \text{ m}$

$$D_{P_1} = 30,75 \text{ mm}, D_{P_2} = 29 \text{ mm}, D_{P_3} = 30 \text{ mm}, D_{P_4} = 29,75 \text{ mm}$$

$$D_3 = (30,75 \text{ mm} - 30 \text{ mm}) = 0,75 \text{ mm}$$

$$D_4 = (29 \text{ mm} - 29,75 \text{ mm}) = -0,75 \text{ mm}$$

$$0,4 \frac{\text{mm}}{\text{m}} \times (10 \text{ m} - (2 \times 0,5 \text{ m})) = 3,6 \text{ mm} \text{ (distância de compensação máxima permitida)}$$

$$(0,75 \text{ mm}) - (-0,75 \text{ mm}) = 1,5 \text{ mm}$$

$$1,5 \text{ mm} \leq 3,6 \text{ mm} \text{ (VERDADE, a unidade encontra-se dentro da calibração)}$$

## Precisão do raio horizontal

1. Coloque a unidade de laser conforme demonstrado, com o laser ligado (ON). Aponte o raio vertical ao primeiro canto ou ponto de referência. Meça metade da distância  $D_1$  e marque o ponto  $P_1$ .

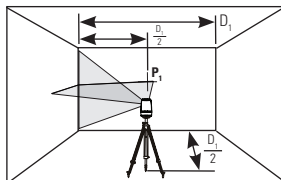

2. Rode a unidade de laser para o outro canto ou ponto de referência.

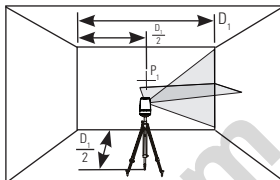

3. Meça as distâncias verticais entre P<sub>1</sub> e o feixe horizontal da segunda localização.

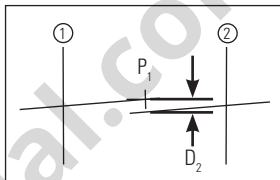

4. Calcule a distância de compensação máxima permitida e compare com D<sub>2</sub>. Se D<sub>2</sub> não for igual ou inferior à distância de compensação máxima calculada, a unidade deve ser devolvida ao seu Distribuidor Stanley.

Distância máxima de compensação:

$$\begin{aligned} \text{Máx.} &= 0,4 \frac{\text{mm}}{\text{m}} \times D_1 \text{ m} \\ &= 0,0048 \frac{\text{pol}}{\text{pés}} \times D_1 \text{ pés} \end{aligned}$$

Compare:

$$D_2 \leq \text{Máx.}$$

Exemplo: D<sub>1</sub> = 5 m, D<sub>2</sub> = 1 mm

$0,4 \frac{\text{mm}}{\text{m}} \times 5 \text{ m} = 2 \text{ mm}$  (distância máxima de compensação permitida)

$1 \text{ mm} \leq 2 \text{ mm}$  (**VERDADE**, a unidade encontra-se dentro da calibração)

## Precisão do raio vertical

1. Meça a altura do caixilho da porta ou do ponto de referência para obter a distância  $D_1$ . Coloque a unidade de laser conforme demonstrado, com o laser ligado (ON). Aponte o raio vertical ao caixilho da porta ou ponto de referência. Marque os pontos  $P_1$ ,  $P_2$  e  $P_3$ , conforme demonstrado.

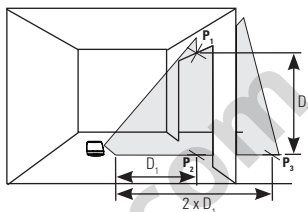

2. Mova a unidade de laser para o lado oposto ao do caixilho da porta ou ponto de referência e alinhe o raio vertical com  $P_2$  e  $P_3$ .

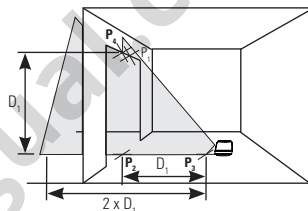

3. Meça as distâncias horizontais entre  $P_1$  e o feixe vertical da segunda localização.

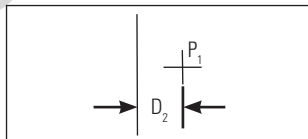

4. Calcule a distância de compensação máxima permitida e compare com  $D_2$ . Se  $D_2$  não for igual ou inferior à distância de compensação máxima calculada, a unidade deve ser devolvida ao seu Distribuidor Stanley.

Distância máxima de compensação:

$$\begin{aligned} \text{Máx.} &= 0,8 \frac{\text{mm}}{\text{m}} \times D_1, \text{ m} \\ &= 0,0096 \frac{\text{pol.}}{\text{pés}} \times D_1, \text{ pés} \end{aligned}$$

Compare:

$$D_2 \leq \text{Máx.}$$

Exemplo:  $D_1 = 2 \text{ m}$ ,  $D_2 = 0,5 \text{ mm}$

$0,8 \frac{\text{mm}}{\text{m}} \times 2 \text{ m} = 1,6 \text{ mm}$  (distância máxima de compensação permitida)

$0,5 \text{ mm} \leq 1,6 \text{ mm}$  (**VERDADE**, a unidade encontra-se dentro da calibração)



A unidade laser não é à prova de água. **NÃO** a molhe. Pode provocar danos nos circuitos internos.

**NÃO** deixe a unidade laser sob a luz directa do Sol nem a exponha a temperaturas elevadas. A estrutura e algumas peças internas são de plástico e podem ficar deformadas com temperaturas elevadas.

**NÃO** armazene a unidade laser num ambiente frio. Pode formar-se humidade nas peças internas ao aquecer. Esta humidade pode embaciar as janelas do laser e causar a corrosão das placas de circuito internas.

Ao trabalhar em locais poeirentos, pode acumular-se alguma sujidade na janela do laser. Retirar a humidade ou sujidade com um pano macio e seco.

**NÃO** utilizar agentes de limpeza ou solventes agressivos.

Guarde a unidade laser na mala de transporte quando não estiver a ser utilizada. Se ficar armazenado durante um longo período, retire as pilhas antes de a guardar para evitar eventuais danos no instrumento.



## Um ano de garantia

A Stanley Tools garante as suas ferramentas electrónicas de medição contra defeitos de material e/ou de fabrico por um ano, a partir da data da compra.

Os produtos com defeito serão reparados ou substituídos, conforme a decisão da Stanley Tools, desde que sejam enviados juntamente com a prova de compra para:

STANLEY IBERIA, S.L.  
Via Auguats 13 – 15 despacho 506  
08006 Barcelona  
SPAIN

Esta Garantia não cobre os defeitos causados por danos acidentais, desgaste, utilização que não esteja em conformidade com as instruções do fabricante ou reparações ou alterações ao produto não autorizadas pela Stanley tools.

A reparação ou substituição ao abrigo desta Garantia não afecta a data de validade da Garantia.

No âmbito permitido pela lei, a Stanley Tools não será responsável, ao abrigo desta Garantia, por prejuízos indirectos ou consequenciais resultantes de defeitos deste produto.

Esta Garantia não pode ser alterada sem a autorização da Stanley Tools.

Esta Garantia não afecta os direitos estatutários dos compradores deste produto.

Esta garantia será regida e interpretada de acordo com as leis de Inglaterra e a Stanley Tools e o comprador concordam irrevogavelmente submeter-se à jurisdição exclusiva dos tribunais de Inglaterra relativamente a qualquer reivindicação ou assunto que surjam relacionados com esta Garantia.

**NOTA IMPORTANTE:** O cliente é responsável pela correcta utilização e manutenção do aparelho. Além disso, o cliente é totalmente responsável pela verificação periódica da precisão da unidade laser e, portanto, pela calibração do aparelho.

A calibração e a manutenção não estão abrangidas pela garantia.

*Sujeito a alterações sem aviso prévio*

## Inhoud

1. Veiligheid
2. Productbeschrijving
3. Technische gegevens
4. Gebruiksaanwijzing
5. IJking
6. Onderhoud en zorg
7. Garantie

## Veiligheid

### Veiligheid van de gebruiker

Lees de Veiligheidsaanwijzingen en Gebruiksaanwijzing aandachtig door alvorens het apparaat in gebruik te nemen. Degene die verantwoordelijk is voor het apparaat moet ervoor zorgen dat alle gebruikers bekend zijn met de aanwijzingen en deze opvolgen.

Bewaar deze instructies om later te kunnen raadplegen.

**BELANGRIJK:** Voor het gemak en veiligheid van de gebruiker zijn de onderstaande labels op het laserapparaat aangebracht. Ze geven aan waar de laser uit het apparaat wordt geprojecteerd. **WEES U ALTIJD BEWUST** van deze plaatsen bij gebruik van het apparaat.



EN 60825-1





**De waarschuwingslabels NIET** verwijderen of beschadigen. Dit apparaat mag alleen gebruikt worden voor nivelleringen en opmetingen zoals in deze gebruiksaanwijzing beschreven zijn.

**Zorg er ALTIJD** voor dat omstanders in de omgeving waar gewerkt wordt zich bewust zijn van het gevaar om direct in de laser te kijken.

**NIET** in combinatie met andere optische instrumenten gebruiken. Het apparaat niet wijzigen, aanpassen of gebruiken voor doeleinden die niet in deze gebruiksaanwijzingen beschreven zijn.

**NIET** in de straal kijken met optische instrumenten zoals vergrootglazen, verrekijkers of telescopen.

**NIET** in de laserstraal kijken of de straal op anderen richten. Zorg ervoor dat het apparaat niet op ooghoogte wordt opgesteld. De ogen worden gewoonlijk beschermd door natuurlijke reacties zoals het knippen van de ogen.

**De laserstraal NIET** op anderen richten.

**Het laserapparaat ALTIJD** op "OFF" (Uit) zetten als het niet gebruikt wordt. Het laserapparaat op "ON" (Aan) laten staan verhoogt het risico dat iemand onbedoeld in de laserstraal kijkt.

**Het laserapparaat NIET** gebruiken in omgevingen waar ontvlambare stoffen, gas of stof aanwezig is.

**Het laserapparaat NIET** demonteren. Het apparaat heeft geen onderdelen die onderhoud vereisen. Het demonteren van het apparaat doet de garantie van dit product vervallen. Het product op geen enkele manier modificeren. Modificatie van het laserapparaat kan blootstelling aan gevaarlijke straling tot gevolg hebben.

**Het apparaat NIET** gebruiken in omgevingen waar gevaar bestaat op explosies.

**OPMERKING:** Omdat de laserstraal een gericht type is, moet het traject van de laserstraal over een relatieve grote afstand gecontroleerd worden om te verzekeren dat de straal geen invloed heeft op andere personen in de omgeving.

## Voorzorgsmaatregels batterijen

---

**WAARSCHUWING:** Batterijen kunnen exploderen of lekken en kunnen letsel of brand veroorzaken. Om dit risico te verminderen:

**ALTIJD** de aanwijzingen en voorzorgsmaatregelen op labels en verpakking van batterijen in acht nemen.

**De polen van de batterijen NIET** kortsluiten.

**Alkalinebatterijen NIET** opladen.

**Oude en nieuwe batterijen NIET** samen gebruiken. Alle batterijen gelijktijdig vervangen met nieuwe batterijen van hetzelfde merk en type.

**Gebruik GEEN** batterijen met verschillende chemische samenstellingen.

**Batterijen NIET** in open vuur gooien.

**Batterijen BUITEN BEREIK** van kinderen houden.

**De batterijen ALTIJD verwijderen** als het apparaat langere tijd niet gebruikt wordt.

**OPMERKING:** Zorg ervoor dat alleen de aanbevolen batterijen worden gebruikt.

**OPMERKING:** Let bij het plaatsen van de batterijen op de juiste polariteit.

## Einde van levensduur

---

**Batterijen NIET** met het normale huisvuil meegeven.

**Oude batterijen ALTIJD inleveren** bij de aangewezen inzamelplaatsen.



**RECYCLE A.U.B.** volgens de plaatselijk voorschriften betreffende het inzamelen en verwerken van elektrisch en elektronisch afval in navolging van de WEEE-richtlijn.

## Verklaring van conformiteit

---

The Stanley Works verklaart dat het CE-merkteken op dit product overeenkomstig de CE markeringsrichtlijn 93/68/EEC is toegepast.

Dit product voldoet aan EN60825-1:2007.

Ga voor nadere bijzonderheden naar [www.stanleyworks.com](http://www.stanleyworks.com).



EN 60825-1



Voldoet aan ROHS-richtlijn

## Productbeschrijving

---



### Inhoud van de verpakking

---

1. Laserapparaat
2. Statief
3. L-vormige steun
4. Paalklem (wordt bevestigd aan L-vormige steun)
5. Laserdoel
6. Etui
7. Batterijen (3 x AA)
8. Gebruiksaanwijzing

## Overzicht van product

---

### Laserapparaat



1. Venster voor kruisstraallaser
2. Transportvergrendeling



3. Toetsenpaneel
4. Waarschuwinglabel voor laser
5. Kapje van batterijhouder



6. 1/4 - 20 schroefdraadfitting

## Statief

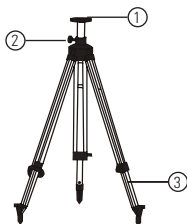

1. 1/4 - 20 schroeffitting
2. Verstelbare middenkolom
3. Verstelbare poten

## L-vormige steun

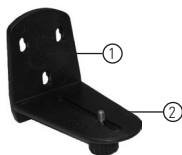

1. Opening
2. 1/4 - 20 schroeffitting

## Paalklem

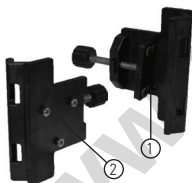

1. Klem
2. 3 Pin key



Nivelleringsnauwkeurigheid:	≤ 4 mm / 10 m (≤ 5/81,28 cm / 30 ft)
Nauwkeurigheid horizontaal / verticaal	≤ 4 mm / 10 m (≤ 5/81,28 cm / 30 ft)
Werkbereik:	Zelfnivelleringsbereik tot ± 4°
Werkafstand:	≤ 10 m (≤ 30 ft)
Laserklasse:	Klasse 1
Lasergolflengte:	635 nm ± 5 nm
Werktijd:	16 h
Voedingsspanning:	4,5 V
Voeding:	3 x AA batterijen (alkaline)
IP-codering:	IP54
Bereik werktemperatuur:	-10° C tot +40° C (+14° F tot +104° F)
Opslagtemperatuur:	-20° C tot +60° C (-4° F tot +140° F)
Gewicht (zonder houder en batterijen):	230 g
Afmeting:	88 mm × 48 mm × 90 mm (3 1/2 in × 1 7/8 in × 3 1/2 in)



## Batterijen installeren / uitnemen

1. Draai het laserapparaat om. Verwijder het kapje van de batterijhouder door het lipje aan te drukken en te ontgrendelen.



2. Batterijen installeren / uitnemen. Let op de polariteit bij het plaatsen van de batterijen.



3. Sluit en vergrendel het kapje van de batterijhouder. Zorg ervoor dat het lipje weer vergrendeld is.



## Laserapparaat



Vergrendeld



Ontgrendeld



Laser aan/uit



Zelfnivellerend



Ingeschakeld



Uitgeschakeld



Lasermodus



Ingeschakeld



Uitgeschakeld

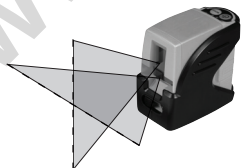

1. Slot voor transport in vergrendelde stand. Zelfnivelleringsfunctie is uitgeschakeld.
2. Slot voor transport in ontgrendelde stand. Zelfnivelleringsfunctie is geactiveerd.
3. Druk op de aan/uit-toets om de laser aan en uit te zetten. De rechter LED-indicator licht groen op als de laser is ingeschakeld.
4. De linker LED-indicator licht blauw op als de laser is ingeschakeld en de zelfnivellerende functie is uitgeschakeld. LED is uit als de zelfnivelleringsfunctie is ingeschakeld.
5. Druk op de lasermodus-toets om tussen verschillende laserstanden te schakelen - alleen horizontaal, alleen verticaal, horizontaal en verticaal.
6. Aan/uit-toets en modustoetsen van de laser zijn altijd geactiveerd. De toetsen kunnen gebruikt worden als de zelfnivelleringsfunctie is in- of uitgeschakeld.
7. Laserstraal/laserstralen knippert/knippen als het laserapparaat buiten werkbereik is. Herpositioneer het laserapparaat om deze te nivelleren.



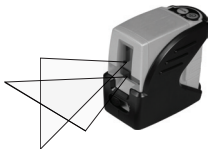

8. Laserstraal/lasertralen dimt/dimmen als de batterij bijna leeg is. Vervang batterijen.

## Statief

---



1. 1/4 - 20 schroefdraadfitting voor laserapparaat.



2. Opvouwbaar voor gemakkelijk vervoer.

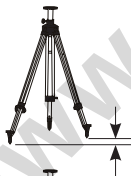

3. Poten zijn instelbaar voor ongelijke ondergrond.



4. Instelbare kolom voor verschillende hoogtes.

## L-vormige steun en paalklem

---



1. 1/4 - 20 schroefdraadfitting voor laserapparaat. Maakt een 360° opstelling van het laserapparaat mogelijk.



2. Bevestig paalklem aan L-vormige steun voor gebruik met statief of andere optionele accessoires.

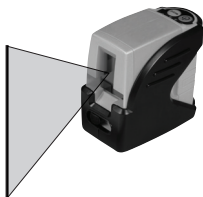

1. Verticaal stellen:  
Gebruik de verticale laser om een verticaal referentievlak te bepalen. Positioneer de gewenste object(en) todat ze gelijkgericht zijn met het verticale referentievlak om te verzekeren dat object(en) loodrecht staan.

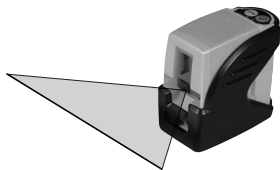

2. Waterpas:  
Gebruik de horizontale laser om het horizontale referentievlak te bepalen. Positioneer de gewenste object(en) zondat deze gelijkgericht zijn met het horizontale referentievlak om te verzekeren dat object(en) waterpas zijn.

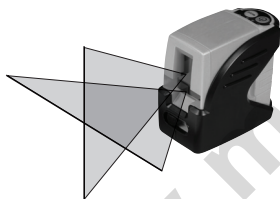

3. Rechthoek:  
Gebruik de verticale of horizontale laserstralen om het punt te bepalen waar de verticale en horizontale stralen elkaar kruisen. Positioneer gewenste object(en) todat ze gelijkgericht zijn met de verticale en horizontale laserstraal om te verzekeren dat object(en) haaks staan.

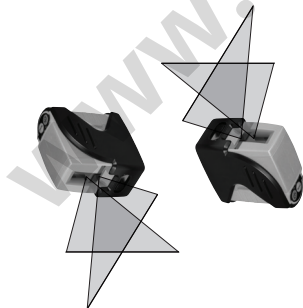

4. Zelfnivellering uitgeschakeld:  
Uitschakelen van de zelfnivellerende functie en maakt het mogelijk de laser een stabiele laserstraal in elke gewenste richting te projecteren.



**OPMERKING:** Het laserapparaat is op de fabriek geijkt. Tijdens gebruik regelmatig de nauwkeurigheid van het laserapparaat controleren om te verzekeren dat de specificaties behouden blijven.

### Nauwkeurigheid nivelleringsstraal

1. Plaats laserapparaat zoals in de afbeelding is getoond met de laser aan. Markeer punt  $P_1$  bij het kruis.

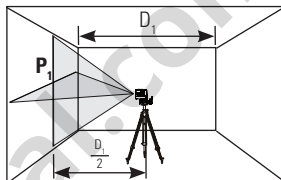

2. roteer het laserapparaat  $180^\circ$  en markeer punt  $P_2$  bij het kruis.

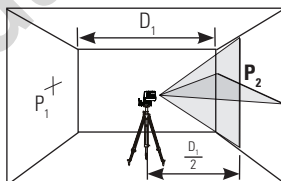

3. Plaats het laserapparaat dicht bij de muur en markeer punt  $P_3$  bij het kruis.

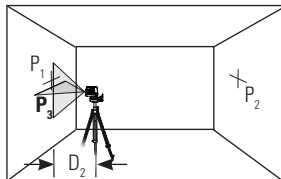

4. roteer het laserapparaat  $180^\circ$  en markeer punt  $P_4$  bij het kruis.

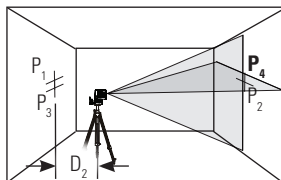

5. Meet de verticale afstand van de vloer naar elk punt. Bereken het verschil tussen de afstanden  $D_{P_1}$  en  $D_{P_3}$  om  $D_3$  te bepalen en de afstanden  $D_{P_2}$  en  $D_{P_4}$  om  $D_4$  te bepalen.
6. Calculeer de maximale toelaatbare offset afstand en vergelijk dit met het verschil van  $D_3$  en  $D_4$  zoals in de vergelijking is getoond. Als het totaal niet minder dan of gelijk is aan de berekende maximale offset afstand, dan moet het apparaat aan de Stanley-distributeur geretourneerd worden.

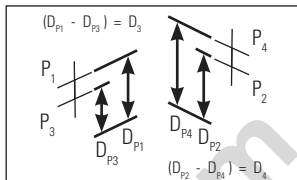

Maximale offset afstand:

$$= 0,4 \frac{\text{mm}}{\text{m}} \times (D_1 \text{ m} - (2 \times D_2 \text{ m}))$$

$$\text{Max} = 0,0048 \frac{\text{in}}{\text{ft}} \times (D_1 \text{ ft} - (2 \times D_2 \text{ ft}))$$

Vergelijk:

$$D_3 - D_4 \leq \pm \text{Max}$$

Voorbeeld:  $D_1 = 10 \text{ m}$ ,  $D_2 = 0,5 \text{ m}$

$$D_{P_1} = 30,75 \text{ mm}, D_{P_2} = 29 \text{ mm}, D_{P_3} = 30 \text{ mm}, D_{P_4} = 29,75 \text{ mm}$$

$$D_3 = (30,75 \text{ mm} - 30 \text{ mm}) = 0,75 \text{ mm}$$

$$D_4 = (29 \text{ mm} - 29,75 \text{ mm}) = -0,75 \text{ mm}$$

$$0,4 \frac{\text{mm}}{\text{m}} \times (10 \text{ m} - (2 \times 0,5 \text{ m})) = 3,6 \text{ mm} \text{ (maximale toelaatbare offset afstand)}$$

$$(0,75 \text{ mm}) - (-0,75 \text{ mm}) = 1,5 \text{ mm}$$

$$1,5 \text{ mm} \leq 3,6 \text{ mm} \text{ (TRUE, apparaat is binnen tolerantie)}$$

## Nauwkeurigheid horizontale straal

1. Plaats laserapparaat zoals in de afbeelding is getoond met de laser aan. Richt de verticale straal op de eerste hoek of op een referentiepunt. Meet de helft van de afstand  $D_1$  en markeer punt  $P_1$ .

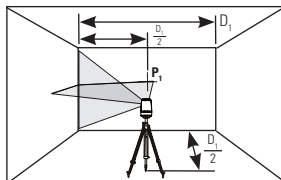

2. Roteer het laserapparaat naar een andere hoek of referentiepunt.

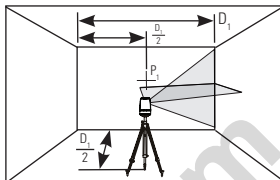

3. Meet de verticale afstand tussen  $P_1$  en de horizontale straal van de 2de locatie.

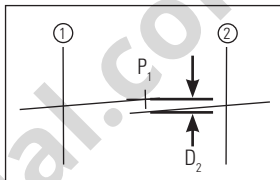

4. Bereken de maximale toelaatbare offset afstand en vergelijk met  $D_2$ . Als  $D_2$  niet minder dan of gelijk is aan de berekende maximale offset afstand, dan moet het apparaat aan de Stanley-distributeur getourneerd worden.

Maximale offset afstand:

$$\begin{aligned} &= 0,4 \frac{\text{mm}}{\text{m}} \times D_1, \text{m} \\ \text{Max} &= 0,0048 \frac{\text{in}}{\text{ft}} \times D_1, \text{ft} \end{aligned}$$

Vergelijk:

$$D_2 \leq \text{Max}$$

Voorbeeld:  $D_1 = 5 \text{ m}$ ,  $D_2 = 1 \text{ mm}$

$$0,4 \frac{\text{mm}}{\text{m}} \times 5 \text{ m} = 2 \text{ mm} \text{ (maximale toelaatbare offset afstand)}$$

$$1 \text{ mm} \leq 2 \text{ mm} \text{ (TRUE, apparaat is binnen tolerantie)}$$

## Nauwkeurigheid verticale straal

1. Meet de hoogte van een deurpost of referentiepunt om de afstand  $D_1$  te bepalen. Plaats laserapparaat zoals in de afbeelding is getoond met de laser aan. Richt de verticale straal op de deurpost of referentiepunt. Markeer punten  $P_1$ ,  $P_2$ , en  $P_3$  zoals getoond.

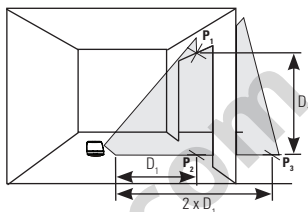

2. Verplaats het laserapparaat naar de tegenovergestelde kant van de deurpost of referentiepunt en richt de verticale straal gelijk met  $P_2$  en  $P_3$ .

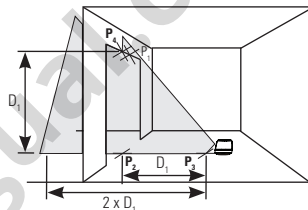

3. Meet de horizontale afstanden tussen  $P_1$  en de verticale straal van de 2de locatie.

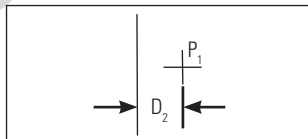

4. Bereken de maximale toelaatbare offset afstand en vergelijk met  $D_2$ . Als  $D_2$  niet minder dan of gelijk is aan de berekende maximale offset afstand, dan moet het apparaat aan de Stanley-distributeur geretourneerd worden.

Maximale offset afstand:

$$= 0,8 \frac{\text{mm}}{\text{m}} \times D_1, \text{ m}$$

$$\text{Max} = 0,0096 \frac{\text{in}}{\text{ft}} \times D_1, \text{ ft}$$

Vergelijk:

$$D_2 \leq \text{Max}$$

Voorbeeld:  $D_1 = 2 \text{ m}$ ,  $D_2 = 0,5 \text{ mm}$

$0,8 \frac{\text{mm}}{\text{m}} \times 2 \text{ m} = 1,6 \text{ mm}$  (maximale toelaatbare offset afstand)

$0,5 \text{ mm} \leq 1,6 \text{ mm}$  (**TRUE**, apparaat is binnen tolerantie)



Het laserapparaat is niet waterdicht. Het apparaat **NIET** nat laten worden. Dit kan schade aan interne circuits veroorzaken.

**Plaats het laserapparaat NIET** in direct zonlicht en stel hem niet bloot aan hoge temperaturen. De behuizing en enkele interne onderdelen zijn van plastic gemaakt en kunnen door hoge temperaturen vervormd worden.

**Het laserapparaat NIET** in een koude omgeving opbergen. Interne onderdelen kunnen beslaan als het apparaat opwarmt. Vochtigheid kan het laservenster beslaan en interne circuit boards corroderen.

Bij gebruik in stoffige omgevingen kan vuil zich op het laservenster verzamelen. Verwijder vocht of vuil met een zachte, droge doek.

**Gebruik GEEN** sterke schoonmaak- of oplosmiddelen.

Bewaar het laserapparaat in de etui als het niet gebruikt wordt. Verwijder de batterijen als het toestel voor langere tijd niet gebruikt wordt om schade door lekkende batterijen te voorkomen.





## Garantie van één jaar

Stanley Tools garandeert elektrische meetapparatuur tegen defecten in materialen en afwerking voor één jaar vanaf de datum van aankoop.

Defecte producten worden gerepareerd of vervangen naar goeddunken van Stanley Tools indien ze samen met het aankoopbewijs worden verzonden naar:

**Stanley Works Benelux**  
**Egide Walsschaertsstraat 14-16**  
**2800 Mechelen**  
**Belgium**

Deze Garantie is niet van toepassing op schade veroorzaakt door ongelukken, slijtage, toepassingen die niet in overeenstemming zijn met de aanwijzingen van de fabrikant of een reparaties of wijziging die niet door Stanley Tools geautoriseerd is.

Reparatie of vervanging onder deze Garantie heeft geen invloed op de verloopdatum van de Garantie.

Voor zover door de wet is toegestaan is Stanley Tools onder deze Garantie niet aansprakelijk voor indirecte schade of gevolgschade veroorzaakt door defecten aan dit product.

Deze Garantie mag niet zonder toestemming van Stanley Tools gewijzigd worden.

Deze Garantie heeft geen invloed op de statutaire rechten van de consumenten die dit product kopen.

Op deze Garantie is Engels recht van toepassing en Stanley Tools en de koper komen overeen dat eventuele geschillen of zaken voortvloeiend uit of in verband met deze Garantie onder de exclusieve jurisdictie van het Engelse recht.

**BELANGRIJKE OPMERKING:** De klant is verantwoordelijk voor het juiste gebruik van en de zorg voor het apparaat. De klant is tevens verantwoordelijk voor de periodieke inspectie van de nauwkeurigheid van het laserapparaat en dus voor de ijking van het apparaat.

Ijking en onderhoud zijn niet gedekt door de garantie.

*Er kunnen wijzigingen worden doorgevoerd zonder voorafgaande kennisgeving.*

## Indhold

1. Sikkerhed
2. Produktbeskrivelse
3. Specifikationer
4. Brugsanvisning
5. Kalibrering
6. Vedligeholdelse og pleje
7. Garanti

## Sikkerhed

### Brugersikkerhed

Læs omhyggeligt sikkerhedsvejledningen og brugermanualen igennem, inden produktet anvendes. Den person, som er ansvarlig for instrumentet, skal sikre, at alle brugere forstår og overholder disse instruktioner.

Gem denne manual til fremtidig brug.

**VIGTIGT:** De følgende mærker sidder på dit laserværktøj af praktiske og sikkerhedsmæssige årsager. De viser, hvor laserstrålen udsendes fra vaterpasset. **VÆR ALTID OPMÆRKSOM** på deres placering, når vaterpasset bruges.



EN 60825-1



**DER MÅ IKKE** fjernes nogen advarselmærkater fra kabinettet. Dette instrument må kun anvendes til nivellerings- og opmålingsopgaver, som det er beskrevet i denne manual.

**VÆR ALTID** sikker på, at omkringstående personer i nærheden af arbejdsstedet er gjort opmærksomme på faren ved at se direkte ind i laserværktøjet.

**MÅ IKKE** anvendes sammen med andre optiske instrumenter. Instrumentet må ikke ændres, manipuleres eller anvendes til andre formål end dem, der er beskrevet i manualen.

**SE IKKE** ind i strålen med optiske hjælpemidler, så som forstørrelsesglas, kikkerter eller teleskoper.

**KIG IKKE** direkte ind i laserstrålen, og ret den ikke direkte mod andre personer. Sørg for, at instrumentet ikke anbringes i øjenhøjde. Øjnene beskyttes normalt af de naturlige afværgereaktioner så som blinkerefleksen.

**RET IKKE** laserstrålen direkte mod andre personer.

**SÆT ALTID** laserværktøjet på "OFF" (SLUKKET), når det ikke er i brug. Hvis laserværktøjet efterlades på "ON" (TÆNDT), øger det faren for, at nogen ved et uheld kommer til at se ind i laserstrålen.

**UNDLAD** at bruge laserværktøjet på letantændelige steder, f.eks. hvor der findes brændbare væsker, gasser eller støv.

**UNDLAD** at skille laserværktøjet ad. Det indeholder ingen dele, som brugeren kan reparere. Hvis laserværktøjet skilles ad, ophæves alle garantier på værktøjet. Produktet må ikke ændres på nogen måde. Ændringer af laserværktøjet kan føre til strålingsfare.

**ANVEND IKKE** instrumentet på steder, hvor der er fare for en eksplosion.

**BEMÆRK:** Idet laserstrålen er af den fokuserede type, skal strålens bane kontrolleres over en relativ lang afstand, og der skal træffes alle nødvendige forholdsregler for at sikre, at strålen ikke kan ramme andre personer.

## Batterisikkerhed

---

**ADVARSEL:** Batterier kan eksplodere eller lække og forårsage skader eller brand. Risikoen herfor kan begrænses:

**FØLG ALTID** alle instruktioner og advarsler på batterimærket og -pakken.

**UNDLAD** at kortslutte batteripolerne.

**UNDLAD** at oplade alkaliske batterier.

**UNDLAD** at blande gamle og nye batterier. Udskift alle batterier med nye batterier af ens mærke og type på én gang.

**UNDLAD** at blande batterier med forskellig type kemi.

**UNDLAD** at brænde batterierne.

**OPBEVAR ALTID** batterier utilgængeligt for børn.

**FJERN ALTID** batterierne, hvis værktøjet ikke skal bruges i flere måneder.

**BEMÆRK:** Sørg for at anvende de korrekte, anbefalede batterier.

**BEMÆRK:** Sørg for at indsætte batterierne korrekt og med korrekt polaritet.

### Efter endt brugstid

---

**UNDLAD AT** kassere dette produkt sammen med husholdningsaffald.

**AFHÆND ALTID** batterierne i overensstemmelse med lokale love.

**GENBRUG VENLIGST** i overensstemmelse med de lokale bestemmelser for indsamling og bortskaffelse af elektrisk og elektronisk affald iflg. WEEE-direktivet.



## Overensstemmelseserklæring

---

Stanley Works erklærer, at CE-mærket på dette produkt er i overensstemmelse med direktivet for CE-mærkning 93/68/EØF.

Produktet overholder EN60825-1:2007.

Se yderligere oplysninger på [www.stanleyworks.com](http://www.stanleyworks.com).



CE



Overholder ROHS

## Produktbeskrivelse

---

### Pakkens indhold

---

1. Laserenhed
2. Trefod
3. L-beslag
4. Stangklemme (fastgøres til L-beslaget)
5. Lasermål
6. Bæretaske
7. Batterier (3 x AA)
8. Brugermanual

### Laserenhed



1. Vindue til krydslinjelaser
2. Transportlås



3. Tastatur
4. Laseradvarselmærkat
5. Dæksel til batterirum



6. 1/4 - 20 monteringsgevind

## Trefod

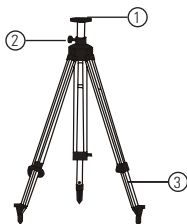

1. 1/4 - 20 skruebeslag
2. Elevationssøjle
3. Justerbare ben

## L-beslag

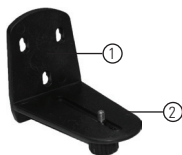

1. Nøglehulsåbninger
2. 1/4 - 20 skruebeslag

## Stangklemme

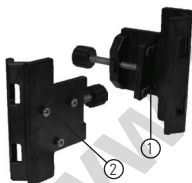

1. Klemme
2. 3-bensstik



Nivelleringsnøjagtighed:	≤ 4 mm / 10 m
Horisontal / vertikal nøjagtighed	≤ 4 mm / 10 m
Arbejdsområde:	Selvnivellering til ±4°
Arbejdsafstand:	≤ 10 m
Laserklasse:	Klasse 1
Laserbølgelængde:	635 nm ± 5 nm
Driftstid:	16 t
Strømspænding:	4,5 V
Strømforsyning:	3 x AA batterier (alkaline)
IP-klasse:	IP54
Driftstemperaturområde:	-10 °C til +40 °C
Opbevaringstemperaturområde:	-20 °C til +60 °C
Vægt (uden fod og batterier):	230 g
Størrelse:	88 mm × 48 mm × 90 mm





## Indsættelse / udtagning af batterier

1. Vend laserenheden om. Åbn dækslet til batterirummet ved at vippe tappen ud.



2. Isætning / udtagning af batterier. Vend batterierne korrekt, når de sættes i laserenheden.



3. Luk og lås dækslet på batterirummet. Sørg for, at tappen låser med et klik.



## Laserenhed



Låst



Ikke låst



Laser TÆNDT/SLUKKET



Selvnivelleringsfunktion



Aktiveret



Deaktiveret



Lasermodus

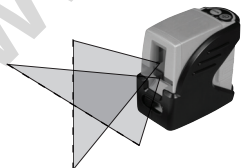

1. Transportlås i låst position.  
Selvnivelleringsfunktionen er deaktiveret.
2. Transportlås i ulåst position.  
Selvnivelleringsfunktionen er aktiveret.
3. Tryk på afbryderen for at TÆNDE og SLUKKE laseren. Den højre LED lyser grønt, når laseren er tændt.
4. Den venstre LED lyser blå, når laseren er tændt med selvnivelleringsfunktionen deaktiveret. LED'en er slukket, når selvnivelleringsfunktionen er aktiveret.
5. Tryk på lasermodus-knappen for at skifte mellem de tilgængelige lasermodi - kun horisontal, kun vertikal, både horisontal og vertikal.
6. Laserstrøm- og lasermodus-knappen er altid i funktion. Kan anvendes både når selvnivelleringsfunktionen er aktiveret og deaktiveret.
7. Laserstrålen (-strålerne) blinker for at vise, at laserenheden er uden for arbejdsområdet. Flyt laseren, så den er mere lige.

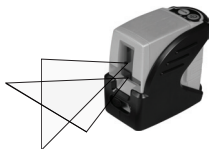

8. Laserstrålen (-strålerne) bliver svagere ved lav batteristrøm. Udskift batterierne.

## Trefod

---



1. 1/4 - 20 skruebeslag til påsætning af laserenhed.



2. Kan klappes sammen, så det er nemmere at transportere.

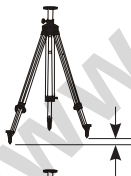

3. Benene kan justeres til ujævne underlag.



4. Elevationssøjlen kan justeres til forskellige højder.

## L-beslag og stangklemme

---



1. 1/4 - 20 skruebeslag til påsætning af laserenhed. Giver mulighed for 360° placering af laserenheden.



2. Fastgør stangklemmen til L-beslaget for anvendelse med trefod eller andet tilbehør.

## Anvendelsesmuligheder

---

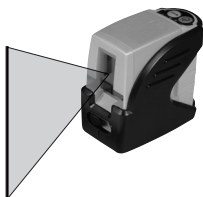

1. I lod:  
Brug den vertikale laserstråle til at danne et vertikalt referenceniveau. Anbring den/de ønskede genstand(e) på linje med det vertikale referenceniveau for at sikre, at den/de er i lod.

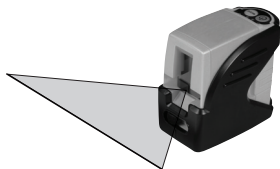

2. I vater:  
Brug den horisontale laserstråle til at danne et horisontalt referenceniveau. Anbring den/de ønskede genstand(e) på linje med det horisontale referenceniveau for at sikre, at den/de er i vater.

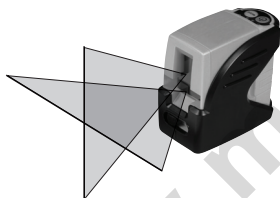

3. Retvinklet:  
Brug både den vertikale og horisontale laserstråle til at finde det sted, hvor den vertikale og horisontale stråle krydser hinanden. Anbring den/de ønskede genstand(e) på linje med både den vertikale og den horisontale laserstråle for at sikre, at den/de er retvinklet.

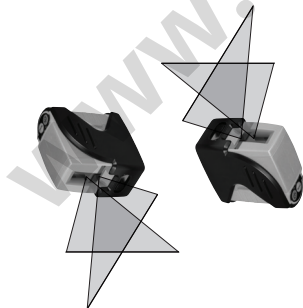

4. Selvsnivellering deaktiveret:  
Når selvsnivelleringsfunktionen deaktiveres, kan laserenheden projicere en solid laserstråle i en vilkårlig retning.



**BEMÆRK:** Laserenheden kalibreres under fremstillingen. Det skal med regelmæssige mellemrum kontrolleres, at laserenheden er nøjagtig, for at sikre at de kalibrerede specifikationer stadig gælder.

## Nøjagtighed af vaterlaserstråle

1. Anbring laserenheden som vist med laseren TÆNDT. Markér punkt  $P_1$  i krydset.

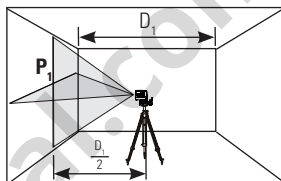

2. Drej laserenheden  $180^\circ$ , og markér punkt  $P_2$  i krydset.

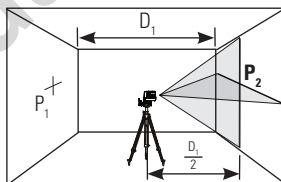

3. Flyt laserenheden tæt på væggen, og markér punkt  $P_3$  i krydset.

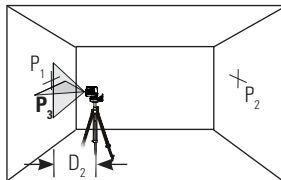

4. Drej laserenheden  $180^\circ$ , og markér punkt  $P_4$  i krydset.

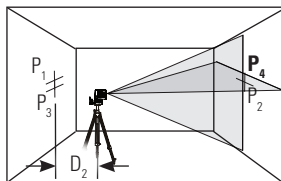

- Mål den vertikale afstand fra gulvet til hvert enkelt punkt. Beregn forskellen mellem afstand  $D_{P_1}$  og  $D_{P_3}$  for at få  $D_3$  og mellem afstand  $D_{P_2}$  og  $D_{P_4}$  for at få  $D_4$ .
- Beregn den maksimalt tilladte offset-

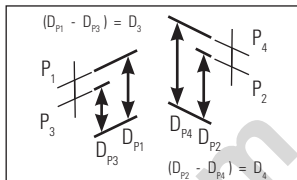

afstand, og sammenlign med forskellen mellem  $D_3$  og  $D_4$  som vist i ligningen. Hvis summen ikke er mindre end eller lig med den beregnede maksimale offset-afstand, skal enheden returneres til din Stanley-forhandler.

**Maksimal offset-afstand:**

$$= 0,4 \frac{\text{mm}}{\text{m}} \times (D_1 \text{ m} - (2 \times D_2 \text{ m}))$$

Maks.  $= 0,0048 \frac{\text{tommer}}{\text{fod}} \times (D_1 \text{ fod} - (2 \times D_2 \text{ fod}))$

**Sammenlign:**

$$D_3 - D_4 \leq \pm \text{Maks.}$$

Eksempel:  $D_1 = 10 \text{ m}$ ,  $D_2 = 0,5 \text{ m}$

$$D_{P_1} = 30,75 \text{ mm}, D_{P_2} = 29 \text{ mm}, D_{P_3} = 30 \text{ mm}, D_{P_4} = 29,75 \text{ mm}$$

$$D_3 = (30,75 \text{ mm} - 30 \text{ mm}) = 0,75 \text{ mm}$$

$$D_4 = (29 \text{ mm} - 29,75 \text{ mm}) = -0,75 \text{ mm}$$

$$0,4 \frac{\text{mm}}{\text{m}} \times (10 \text{ m} - (2 \times 0,5 \text{ m})) = 3,6 \text{ mm} \text{ (maksimalt tilladte offset-afstand)}$$

$$(0,75 \text{ mm}) - (-0,75 \text{ mm}) = 1,5 \text{ mm}$$

$$1,5 \text{ mm} \leq 3,6 \text{ mm} \text{ (NØJAGTIGT INDSTILLET, enheden er inden for kalibreringen)}$$

## Nøjagtighed af horisontal laserstråle

- Anbring laserenheden som vist med laseren TÆNDT. Ret den vertikale stråle mod det første hjørne eller referencepunkt. Mål halvdelen af afstand  $D_1$ , og markér punkt  $P_1$ .

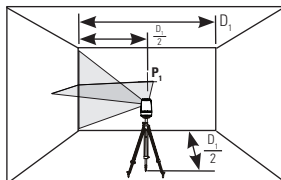

2. Drej laserenheden mod det andet hjørne eller referencepunkt.

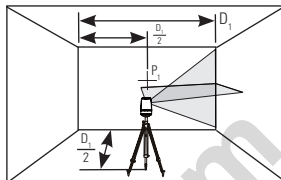

3. Mål den vertikale afstand mellem  $P_1$  og den horisontale stråle fra den 2. position.

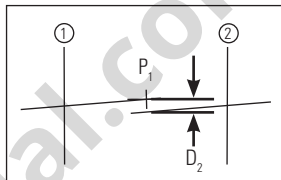

4. Beregn den maksimalt tilladte offset-afstand, og sammenlign med  $D_2$ . Hvis  $D_2$  ikke er mindre end eller lig med den beregnede maksimale offset-afstand, skal enheden returneres til din Stanley-forhandler.

Maksimal offset-afstand:

$$= 0,4 \frac{\text{mm}}{\text{m}} \times D_1, \text{ m}$$

$$\text{Maks.} = 0,0048 \frac{\text{tommer}}{\text{fod}} \times D_1, \text{ fod}$$

Sammenlign:

$$D_2 \leq \text{Maks.}$$

Eksempel:  $D_1 = 5 \text{ m}$ ,  $D_2 = 1 \text{ mm}$

$$0,4 \frac{\text{mm}}{\text{m}} \times 5 \text{ m} = 2 \text{ mm} \text{ (maksimalt tilladt offset-afstand)}$$

$$1 \text{ mm} \leq 2 \text{ mm} \text{ (NØJAGTIGT INDSTILLET, enheden er inden for kalibreringen)}$$



## Nøjagtighed af vertikal laserstråle

1. Mål højden på en dørkarm eller til et referencepunkt for at få afstand  $D_1$ . Anbring laserenheden som vist med laseren TÆNDT. Ret den vertikale stråle mod dørkarmen eller referencepunktet. Markér punkt  $P_1$ ,  $P_2$  og  $P_3$  som vist.

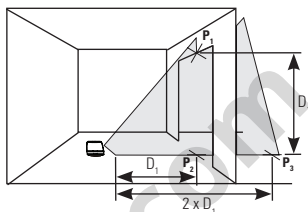

2. Flyt laserenheden til den modsatte side af dørkarmen eller referencepunktet, og få den vertikale stråle til at flugte med  $P_2$  og  $P_3$ .

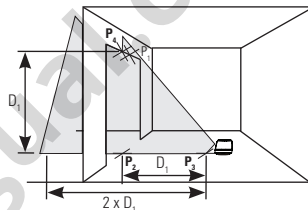

3. Mål den horisontale afstand mellem  $P_1$  og den vertikale stråle fra den 2. position.

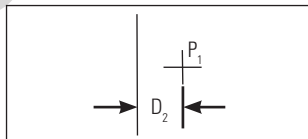

4. Beregn den maksimalt tilladte offset-afstand, og sammenlign med  $D_2$ . Hvis  $D_2$  ikke er mindre end eller lig med den beregnede maksimale offset-afstand, skal enheden returneres til din Stanley-forhandler.

Maksimal offset-afstand:

$$= 0,8 \frac{\text{mm}}{\text{m}} \times D_1, \text{ m}$$

Maks.

$$= 0,0096 \frac{\text{tommer}}{\text{fod}} \times D_1, \text{ fod}$$

Sammenlign:

$$D_2 \leq \text{Maks.}$$

Eksempel:  $D_1 = 2 \text{ m}$ ,  $D_2 = 0,5 \text{ mm}$

$$0,8 \frac{\text{mm}}{\text{m}} \times 2 \text{ m} = 1,6 \text{ mm} \text{ (maksimalt tilladt offset-afstand)}$$

$0,5 \text{ mm} \leq 1,6 \text{ mm}$  (**NØJAGTIGT INDSTILLET**, enheden er inden for kalibreringen)



Laserenheden er ikke vandtæt. **MÅ IKKE** blive våd. De indvendige kredsløb kan tage skade.

**LAD IKKE** laserenheden være ude i direkte sollys, og undlad at udsætte den for høje temperaturer. Huset og visse indvendige dele er fremstillet af plastik og kan miste formen ved høje temperaturer.

**UNDLAD** at opbevare laserenheden på et koldt sted. Der kan danne sig fugt på de indvendige dele, når værktøjet varmes op. Denne fugt kan danne dug på laservinduerne og forårsage tæring af de indvendige kredsløb.

Når der arbejdes på støvede steder, kan der samle sig støv på laservinduet. Fjern al støv eller fugt med en blød, tør klud.

**DER MÅ IKKE** bruges skræppe rengøringsmidler eller opløsningsmidler.

Laserenheden skal opbevares i sin emballage, når den ikke er i brug. Hvis den opbevares i længere tid, skal batterierne fjernes forud for opbevaringen for at forhindre, at instrumentet eventuelt tager skade.



## Et års garanti

Stanley Tools garanterer, at de elektroniske måleværktøjer er fri for fejl i materialer og/eller fremstilling i ét år fra købsdatoen.

Defekte produkter vil blive repareret eller erstattet, efter Stanley Tools' valg, hvis enheden sammen med kvittering sendes til:

Stanley Nordic  
Ndr. Strandvej 119b  
DK-3450 Hellebæk  
Denmark

Denne garanti dækker ikke defekter, der skyldes hændelige skader, slitage, anvendelse, der ikke stemmer overens med producentens instruktioner, eller reparationer eller ændringer af produktet, som ikke er godkendt af Stanley Tools.

Reparation eller ombytning under denne garanti påvirker ikke garantiens udløbsdato.

I det omfang, loven tillader, kan Stanley Tools ikke holdes ansvarlig under denne garanti for indirekte tab eller driftstab som følge af defekter ved dette produkt.

Denne garanti må ikke ændres uden godkendelse fra Stanley Tools.

Denne garanti påvirker ikke de lovmæssige rettigheder for forbrugerkøb vedrørende dette produkt.

Denne garanti skal reguleres af og fortolkes i henhold til Englands love, og både Stanley Tools og køberen accepterer på uigenkaldelig vis, at de engelske domstole er eneste værneting i forbindelse med alle erstatningskrav og anliggender, der måtte opstå under eller i forbindelse med denne garanti.

**VIGTIG BEMÆRKNING:** Kunden er ansvarlig for, at instrumentet anvendes og vedligeholdes korrekt. Derudover er kunden helt ansvarlig for at kontrollere laserenhedens nøjagtighed med regelmæssige mellemrum og dermed for kalibreringen af instrumentet.

Garantien dækker ikke kalibrering og vedligeholdelse.

*Kan ændres uden varsel*

## Innehåll

1. Säkerhet
2. Produktbeskrivning
3. Specifikationer
4. Bruksanvisning
5. Kalibrering
6. Underhåll och service
7. Garanti

## Säkerhet

### Användarsäkerhet

Läs noggrant igenom säkerhetsinstruktionerna och användarmanualen innan du använder denna produkt. Den som är ansvarig för instrumentet måste se till att alla användare förstår och följer dessa instruktioner.

Spara denna manual för framtida bruk.

**OBS!** Följande dekaler finns på ditt laserverktyg för att underlätta arbetet och öka säkerheten. De anger var passet skickar ut laserljus. **TÄNK ALLTID PÅ** var laserstrålen utgår ifrån när du använder passet.



EN 60825-1



**AVLÄGSNA INTE** varningsetikett(er) på höljet. Detta instrument får endast användas för nivellerings- och planritningsuppgifter enligt beskrivningen i denna manual.

**Se ALLTID till** att personer som eventuellt befinner sig i närheten informeras om riskerna med att titta rakt in i laserverktyget.

**FÅR INTE** användas i kombination med andra optiska instrument. Modifiera inte instrumentet, eller manipulera det, eller använd det i andra applikationer än de som anges i manualen.

**TITTA INTE** i laserstrålen med optiska hjälpmedel, t.ex. förstoringsglas, kikare eller teleskop.

**TITTA INTE** in i lasern och rikta den inte mot andra personer. Se till att instrumentet inte är inställt i ögonhöjd. Ögonen skyddas normalt av naturliga avvärjningsreaktioner som blinkreflexen.

**RIKTA INTE** laserstrålen mot andra människor.

**STÄLL ALLTID** laserverktyget i läge "OFF" när det inte används. Om laserverktyget är kvar på "ON" ökar risken för att någon oavsiktligt stirrar rakt in i laserstrålen.

**ANVÄND INTE** laserverktyget när det finns risk för antändning, till exempel i närheten av lättantändliga vätskor, gaser eller damm.

**TA INTE** isär laserverktyget. Det finns inga komponenter inuti som kan underhållas av användaren. Om laserverktyget plockas isär upphör alla garantier för produkten att gälla. Ändra inte produkten på något sätt. Ändring av laserverktyget kan medföra risk för strålningsfara.

**ANVÄND INTE** detta instrument i områden där det råder explosionsfara.

**OBS!** Eftersom laserstrålen är av den fokuserade typen, måste du kontrollera strålens väg över ett relativt långt avstånd och vidta alla nödvändiga försiktighetsåtgärder för att strålen inte ska träffa andra personer.

## Batterisäkerhet

---

**VARNING:**Batterier kan explodera eller läcka och kan orsaka skada eller brand. För att minska denna risk:

**FÖLJ ALLTID** instruktioner och varningar på batterietiketten och förpackningen.

**KORTSLUT INTE** batteriklämmorna.

**LADDA INTE** alkaliska batterier.

**BLANDA INTE** gamla och nya batterier. Byt ut alla samtidigt mot nya batterier av samma märke och sort.

**BLANDA INTE** batterikemikalier.

**KASTA INTE** batterier i elden.

**FÖRVARA ALLTID** batterier utom räckhåll för barn.

**AVLÄGSNA ALLTID** batterierna om enheten inte ska användas på flera månader.

**OBS!** Se till att rätta batterier används enligt rekommendation.

**OBS!** Se till att batterierna sätts i på korrekt sätt, med korrekt polaritet.

## End of Life

---

**KASTA INTE** denna produkt tillsammans med hushållsavfallet.

**KASSERA ALLTID** batterier enligt lokala föreskrifter.

**LÄMNA TILL ÅTERVINNING** enligt lokala bestämmelser för insamling och kassering av elektriskt och elektroniskt avfall enligt WEEE-direktivet..



## Deklaration om överensstämmelse

---

Stanley Works deklarerar att denna produkt har fått CE-märkning enligt CE-märkningsdirektivet 93/68/EEG.

Produkten följer standarden EN60825-1:2007.

Se [www.stanleyworks.com](http://www.stanleyworks.com) för vidare information.



Uppfyller kraven i  
RoHS-direktivet

## Produktbeskrivning

---

### Förpackningens innehåll

---

1. Laserenhet
2. Stativ
3. L-fäste
4. Stångklämma (fästs vid L-fästet)
5. Lasermål
6. Bärfodral
7. Batterier (3 x AA)
8. Användarmanual

### Laserenhet



1. Fönster för krysslaser
2. Transportlås



3. Tangentbord
4. Laservarningsetikett
5. Batterilucka



6. 1/4 - 20 gängfäste



## Stativ

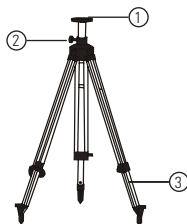

1. 1/4 - 20 skruvfäste
2. Högbar stav
3. Inställbara ben

## L-fäste

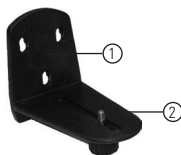

1. Nyckelhålsuttag
2. 1/4 - 20 skruvfäste

## Stångklämma

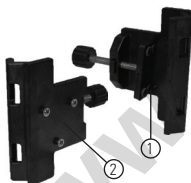

1. Klämma
2. 3-stiftsfäste



Nivelleringsprecision:	≤ 4 mm / 10 m (≤ 5/32 in / 30 ft)
Horisontell/vertikal precision	≤ 4 mm / 10 m (≤ 5/32 in / 30 ft)
Arbetsområde:	Självnivellerande till ±4°
Arbetsavstånd:	≤ 10 m (≤ 30 ft)
Laserklass:	Klass 1
Laservåglängd:	635 nm ± 5 nm
Drifftid:	16 h
Strömförbrukning:	4,5 V
Nätanslutning:	3 x AA-batterier (alkaliska)
IP-klassning:	IP54
Drifttemperatur:	-10° C till +40° C (+14° F till +104° F)
Förvaringstemperatur:	-20° C till +60° C (-4° F till +140° F)
Vikt (utan underdel och batterier):	230 g (8 oz)
Storlek:	88 mm × 48 mm × 90 mm (3 1/2 in × 1 7/8 in × 3 1/2 in)



## Sätta i och ta ut batterier

1. Öppna locket till batterifacket genom att böja ut öppningsfliken.



2. Sätta i / ta ur batterier. Placera batterierna i rätt riktning i laserenheten.



3. Stäng och lås locket till batterifacket. Se till att locket klickar på plats.



## Laserenhet



Laser PÅ/AV

Självnivellerande



Aktiverad



Avaktiverad



Laserläge



Aktiverad



Avaktiverad

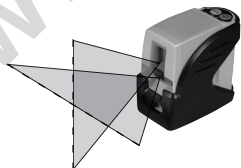

1. Transportlås i låst läge.  
Självnivellerering är avaktiverad.
2. Transportlås i olåst läge.  
Självnivellerering aktiverad.
3. Tryck på strömknappen för att sätta på/  
stänga av lasern. Högra lysdioden lyser grönt  
när strömmen är på.
4. Vänster lysdiod lyser blått när lasern är på  
med avaktiverad självnivelleringsfunktion.  
Lysdioden är släckt när självnivelleringen är  
på.
5. Tryck på knappen för laserläge för att växla  
mellan olika laserlägen - endast horisontellt,  
endast vertikalt, både horisontellt och  
vertikalt.
6. Strömknappen och knappen för laserläge  
är alltid aktiverade. Kan användas både när  
självnivellerering är aktiverad och när den är  
avaktiverad.
7. Laserstrålen/-strålarna blinkar för att visa  
att laserenheten är utanför arbetsområdet.  
Flytta laserenheten så den är mer i våg.

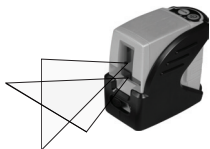

8. Laserstrålen/-strålarna blir matta när batteriet är svagt. Byt batterier.

## Stativ

---



1. 1/4 - 20 skruvfäste för att sätta fast laserenheten.



2. Hopfällbar för lättare transport.

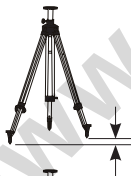

3. Benen kan justeras för ojämnt underlag.



4. Den höjbara staven kan justeras för olika höjd.

## L-fäste och stavklämma

---



1. 1/4 - 20 skruvfäste för att sätta fast laserenheten. Gör att laserenheten kan vridas 360°.



2. Fäst stångklämman på L-fästet för användning med stativ eller andra tillval.

## Användning

---

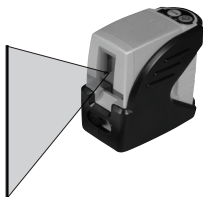

1. **Lod:**  
Skapa ett vertikalt referensplan med hjälp av den vertikala laserstrålen. Justera önskat objekt tills det är i linje med det vertikala referensplanet för att säkerställa att objektet är i lod.

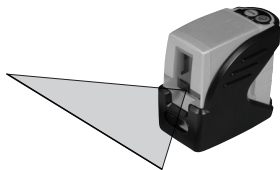

2. **Våg:**  
Skapa ett horisontellt referensplan med hjälp av den horisontella laserstrålen. Justera objektet tills det är i linje med det horisontella referensplanet för att säkerställa att objektet är i våg.

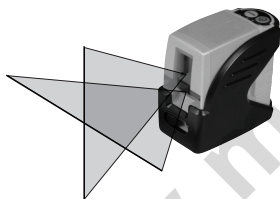

3. **Rät vinkel:**  
Använd både de vertikala och horisontella laserstrålarna för att hitta en punkt där de vertikala och horisontella strålarna korsas. Justera objektet/en så de är i linje med både de vertikala och de horisontella laserstrålarna för att säkerställa att objektet/en är i rät vinkel.

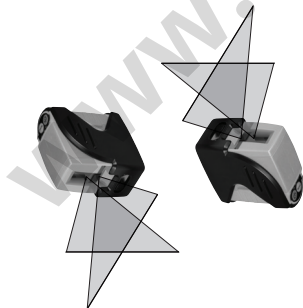

4. **Självnivellering avaktiverad:**  
När man avaktiverar självnivelleringsfunktionen kan laserenheten projicera en fast laserstråle i vilken riktning som helst.



**OBS!** Laserenheten har kalibrerats vid tillverkningen. Kontrollera enhetens precision regelbundet så att de kalibrerade specifikationerna upprätthålls.

## Våglinjens precision

1. Placera laserenheten enligt bilden, med lasern påslagen. Markera punkt  $P_1$  i krysset.

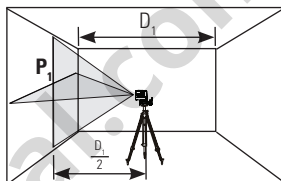

2. Vrid laserenheten 180° och markera punkt  $P_2$  i krysset.

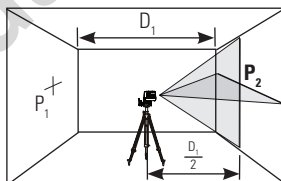

3. Flytta laserenheten intill väggen och markera punkt  $P_3$  i krysset.

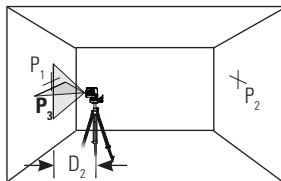

4. Vrid laserenheten 180° och markera punkt  $P_4$  i krysset.

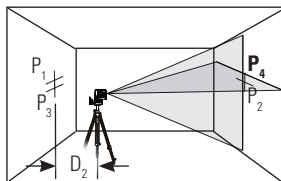



5. Mät det vertikala avståndet från golvet till varje punkt. Beräkna skillnaden mellan avstånden  $D_{P_1}$  och  $D_{P_3}$  för att få  $D_3$  och avstånden  $D_{P_2}$  och  $D_{P_4}$  för att få  $D_4$ .

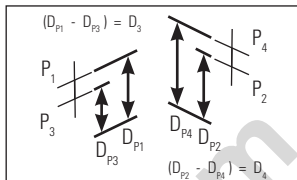

6. Beräkna högsta tillåtna förskjutningsavstånd och jämför med skillnaden mellan  $D_3$  och  $D_4$  som ekvationen visar. Om summan inte är mindre än eller lika med det beräknade högsta förskjutningsavståndet måste du lämna tillbaka enheten till din Stanley-distributör.

Högsta förskjutningsavstånd

$$= 0,4 \frac{\text{mm}}{\text{m}} \times (D_1 \text{ m} - (2 \times D_2 \text{ m}))$$

$$\text{Max} = 0,0048 \frac{\text{in}}{\text{ft}} \times (D_1 \text{ ft} - (2 \times D_2 \text{ ft}))$$

Jämför:

$$D_3 - D_4 \leq \pm \text{Max}$$

Exempel:  $D_1 = 10 \text{ m}$ ,  $D_2 = 0,5 \text{ m}$

$$D_{P_1} = 30,75 \text{ mm}, D_{P_2} = 29 \text{ mm}, D_{P_3} = 30 \text{ mm}, D_{P_4} = 29,75 \text{ mm}$$

$$D_3 = (30,75 \text{ mm} - 30 \text{ mm}) = 0,75 \text{ mm}$$

$$D_4 = (29 \text{ mm} - 29,75 \text{ mm}) = -0,75 \text{ mm}$$

$$0,4 \frac{\text{mm}}{\text{m}} \times (10 \text{ m} - (2 \times 0,5 \text{ m})) = 3,6 \text{ mm} \text{ (högsta tillåtna förskjutningsavstånd)}$$

$$(0,75 \text{ mm}) - (-0,75 \text{ mm}) = 1,5 \text{ mm}$$

$$1,5 \text{ mm} \leq 3,6 \text{ mm} \text{ (SANT, enheten är inom kalibreringen)}$$

## Horisontallinjens precision

1. Placera laserenheten enligt bilden, med lasern påslagen. Rikta vertikal stråle mot första hörnet eller referenspunkten. Mät upp hälften av avståndet  $D_1$  och markera punkt  $P_1$ .

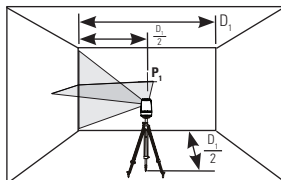

2. Roterar laserenheten till ett annat hörn eller referenspunkt.

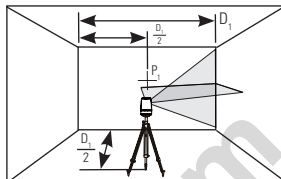

3. Mät de vertikala avstånden mellan  $P_1$  och den horisontella strålen från den andra platsen.

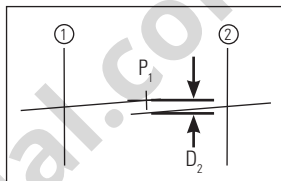

4. Beräkna högsta tillåtna förskjutningsavstånd och jämför med  $D_2$ . Om  $D_2$  inte är mindre än eller lika med det beräknade högsta förskjutningsavståndet måste du lämna tillbaka enheten till din Stanley-distributör.

#### Högsta förskjutningsavstånd

$$\begin{aligned} \text{Max} &= 0,4 \frac{\text{mm}}{\text{m}} \times D_1, \text{m} \\ &= 0,0048 \frac{\text{in}}{\text{ft}} \times D_1, \text{ft} \end{aligned}$$

Jämför:

$$D_2 \leq \text{Max}$$

Exempel:  $D_1 = 5 \text{ m}$ ,  $D_2 = 1 \text{ mm}$

$$0,4 \frac{\text{mm}}{\text{m}} \times 5 \text{ m} = 2 \text{ mm} \text{ (högsta tillåtna förskjutningsavstånd)}$$

$$1 \text{ mm} \leq 2 \text{ mm} \text{ (SANT, enheten är inom kalibreringen)}$$

## Vertikallinjens precision

1. Mät höjden på en dörrkarm eller referenspunkt för att få avståndet  $D_1$ . Placera laserenheten enligt bilden, med lasern påslagen. Rikta den vertikala strålen mot dörrkarmen eller referenspunkten. Markera punkterna  $P_1$ ,  $P_2$  och  $P_3$  enligt bilden.

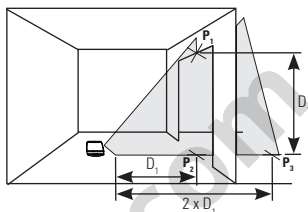

2. Flytta laserenheten till motsatta sidan av dörrkarmen eller referenspunkten och rikta den vertikala strålen i linje med  $P_2$  och  $P_3$ .

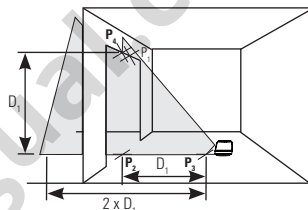

3. Mät de horisontella avstånden mellan  $P_1$  och den vertikala strålen från den andra platsen.

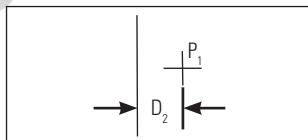

4. Beräkna högsta tillåtna förskjutningsavstånd och jämför med  $D_2$ . Om  $D_2$  inte är mindre än eller lika med det beräknade högsta förskjutningsavståndet måste du lämna tillbaka enheten till din Stanley-distributör.

### Högsta förskjutningsavstånd

$$\begin{aligned} \text{Max} &= 0,8 \frac{\text{mm}}{\text{m}} \times D_1, \text{ m} \\ &= 0,0096 \frac{\text{in}}{\text{ft}} \times D_1, \text{ ft} \end{aligned}$$

Jämför:

$$D_2 \leq \text{Max}$$

Exempel:  $D_1 = 2 \text{ m}$ ,  $D_2 = 0,5 \text{ mm}$

$0,8 \frac{\text{mm}}{\text{m}} \times 2 \text{ m} = 1,6 \text{ mm}$  (högsta tillåtna förskjutningsavstånd)

$0,5 \text{ mm} \leq 1,6 \text{ mm}$  (**SANT**, enheten är inom kalibreringen)



Laserenheten är inte vattentät. **FÅR INTE** utsättas för väta. Det kan resultera i skador på inre kretsar.

**LÄMNA INTE** laserenheten ute i direkt solljus och utsätt den inte för höga temperaturer. Höljet och en del inre delar är gjorda av plast och kan deformeras vid höga temperaturer.

**FÖRVARA INTE** laserenheten i en kall omgivning. Det kan bildas fukt på inre delar när den värms upp. Fukten kan imma igen laserfönster och orsaka korrosion på inre kretskort.

Det kan att samlas en del smuts på laserfönstret när du arbetar på dammiga ställen. Avlägsna eventuell fukt eller smuts med en mjuk, ren trasa.

**ANVÄND INTE** aggressiva rengöringsmedel eller lösningsmedel.

Förvara enheten i dess låda när den inte används. I händelse av förvaring under längre tid, ta bort batterierna för att förhindra att instrumentet förstörs..



## Ett års garanti

Stanley Tools ställer garanti för sina elektroniska mätverktyg mot materialfel och tillverkningsfel i ett år från köpdatum.

Felaktiga produkter kommer att repareras eller bytas ut enligt Stanleys eget gottfinnande om de skickas tillsammans med inköpsbevis till:

Suomen Stanley Oy  
PL 186  
FIN-01511 Vantaa  
Finland

Denna garanti täcker inte fel som orsakats av skador till följd av olycka eller förslitning, annan användning än i överensstämmelse med tillverkarens instruktioner eller reparation eller ändring av produkten som inte godkänts av Stanley Tools.

Reparation eller utbyte enligt garantin påverkar inte garantins utgångsdatum.

I den utsträckning som tillåts av lagen skall Stanley Tools inte hållas skyldig under denna garanti för indirekta förluster eller följdförluster som resultat av felaktigheter i produkten.

Denna Garanti får inte ändras utan tillstånd från Stanley Tools.

Denna garanti påverkar inte de lagstadgade rättigheterna vid konsumentköp av denna produkt.

Denna Garanti skall styras av och konstrueras i enlighet med lagarna i England och Stanley Tools och köparen samtycker var och en oåterkalleligen att lyda jurisdiktionen hos domstolarna i Englands ensamrätt över varje krav eller fråga som uppkommer under eller i samband med denna Garanti.

**VIKTIGT!** Kunden ansvarar för att verktyget används och sköts på rätt sätt. Kunden bär dessutom det fulla ansvaret för att kontrollera arbetet medan det pågår och därmed även för kalibreringen av verktyget.

Kalibrering och skötsel täcks inte av garantin.

*Reservation för ändringar utan föregående meddelande*

www.mengual.com



© 2010 The Stanley Works  
Stanley Europe, Egide Walschaertsstraat 14-16,  
2800 Mechelen, Belgium  
Issue 1 03/10

**WWW.STANLEYWORKS.COM**