

Magic2

VETRO

Magic2 Vetro is the new **PATENTED** and **INVISIBLE** sliding system for external wall doors with soft-closing. The system might be fixed with exposed studs or bundle and it is suitable to monolithic or laminated glasses, from 8 up to 12.7 mm of thickness.

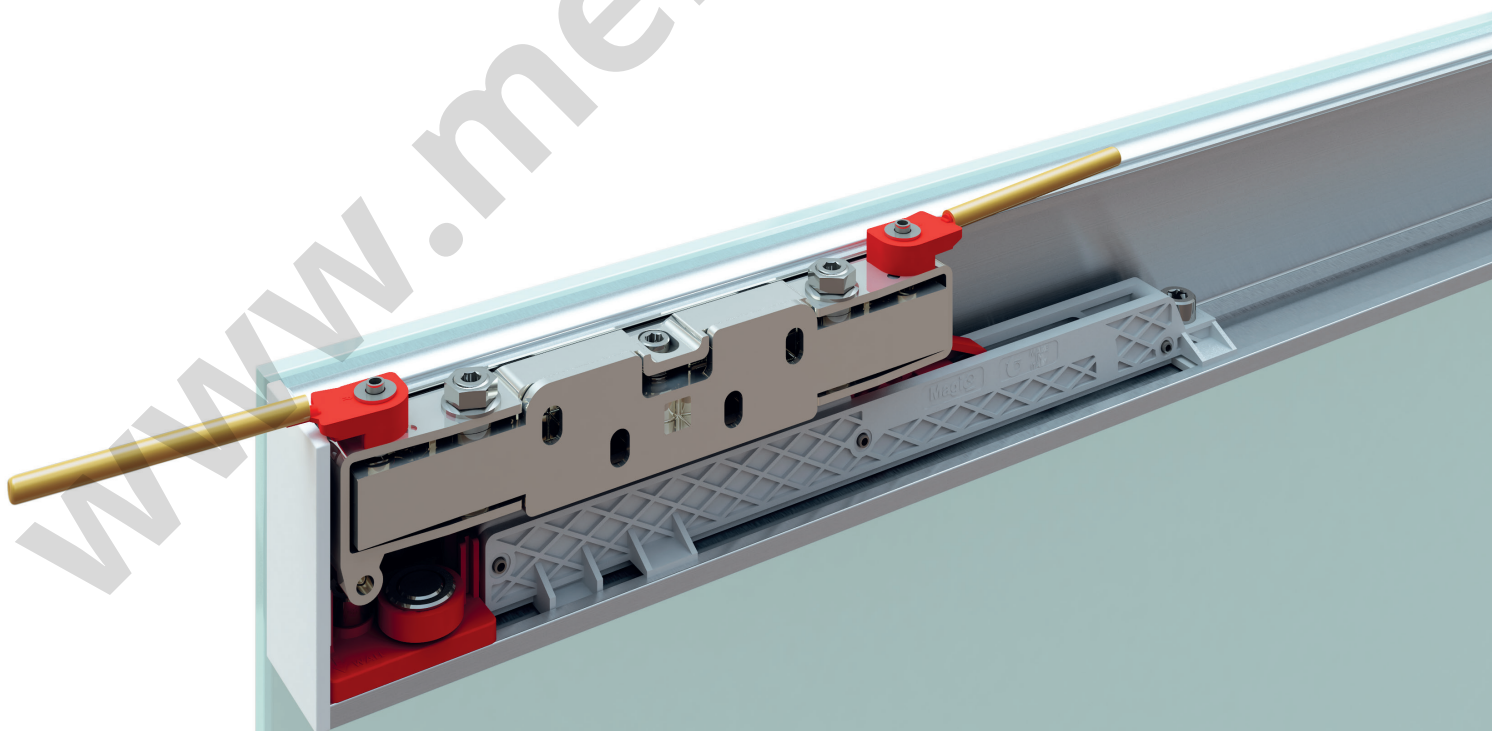









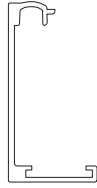
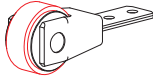
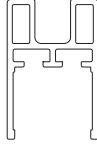



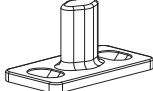
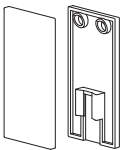
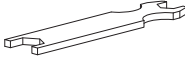
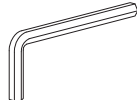
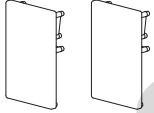
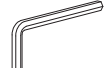
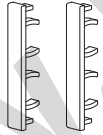

Magic2 Vetro è l'innovativo **SISTEMA INVISIBILE BREVETTATO** per porte scorrevoli in vetro esterno muro con fermi ammortizzati. Il sistema può essere fissato tramite borchie o fascia a vista ed è adatto per vetri monolitici o stratificati, con spessore da 8 a 12.7 mm

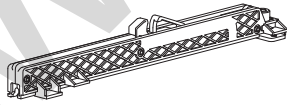

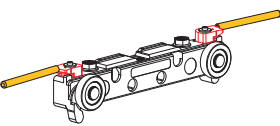
dressing rooms

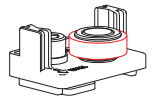

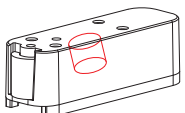
PATENTED

N°	Barcode		KG		N°	Barcode		KG	
1	2850 (8000.02850)		80		12	2857		80	PATENTED
2	2863 (8000.02863)		80	Glass thk. Vetri sp. 8 mm (5/16")	13	2193 (8230.02193)		80	
	2862 (8000.02862)			Glass thk. Vetri sp. 10 mm (3/8")	14	2195		80	
	2861 (8000.02861)			Glass thk. Vetri sp. 12 mm (1/2")	15	2197/A		80	
3	2860 (8230.02860)		80		16	2859		80	
4	2198 (8000.02198)		80		17	2855		80	
5	2851/N		80		18	1025		80	
	2851/A				19	538		80	
6	2866		80		20	654		80	
7	2199		80		21	1164		80	
8	2854		80	PATENTED	22	FISCHER UX6		80	
9	2852		80	PATENTED	23	4,5x40		80	
10	2856		80	PATENTED	24	4x30		80	
11	2858		80	PATENTED	25	4x20		80	
					26	FISCHER SX5		80	



80 kg



N.2 Soft damper stoppers
N.2 Fermi ammortizzati



Customizable door width
Larghezza porta personalizzabile



Patented system
Sistema brevettato

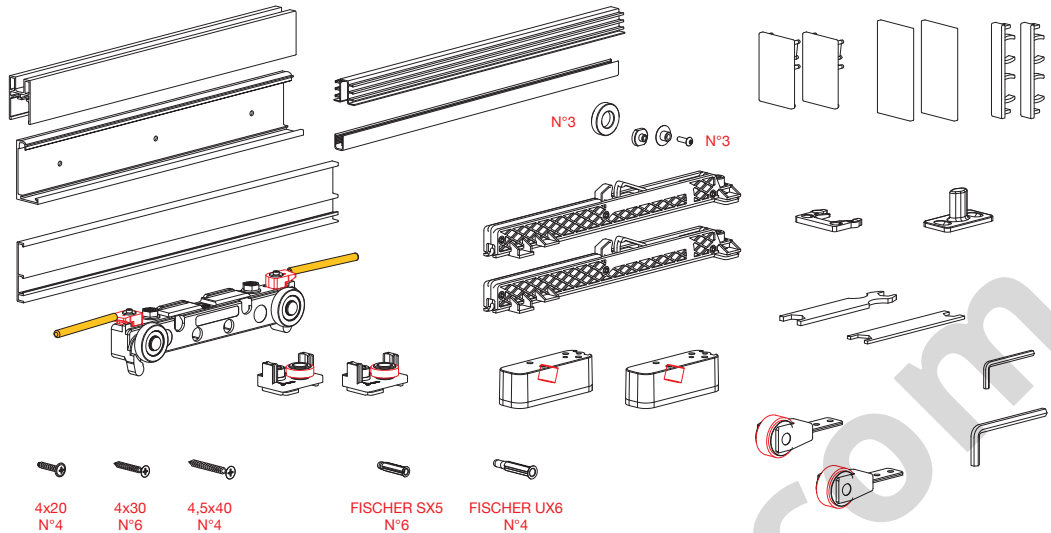

OLD CODE	NEW CODE	→ ←	
MAGIC2/1100/V/08	K.0041.1.02	8 mm (5/16")	1100 mm
MAGIC2/1100/V/10	K.0041.2.02	10 mm (3/8")	
MAGIC2/1100/V/12	K.0041.3.02	12 mm (1/2")	
MAGIC2/1800/V/8	K.0042.1.02	8 mm (5/16")	1800 mm
MAGIC2/1800/V/10	K.0042.2.02	10 mm (3/8")	
MAGIC2/1800/V/12	K.0042.3.02	12 mm (1/2")	

DESCRIPTION OF MEASURES / DESCRIZIONE MISURE

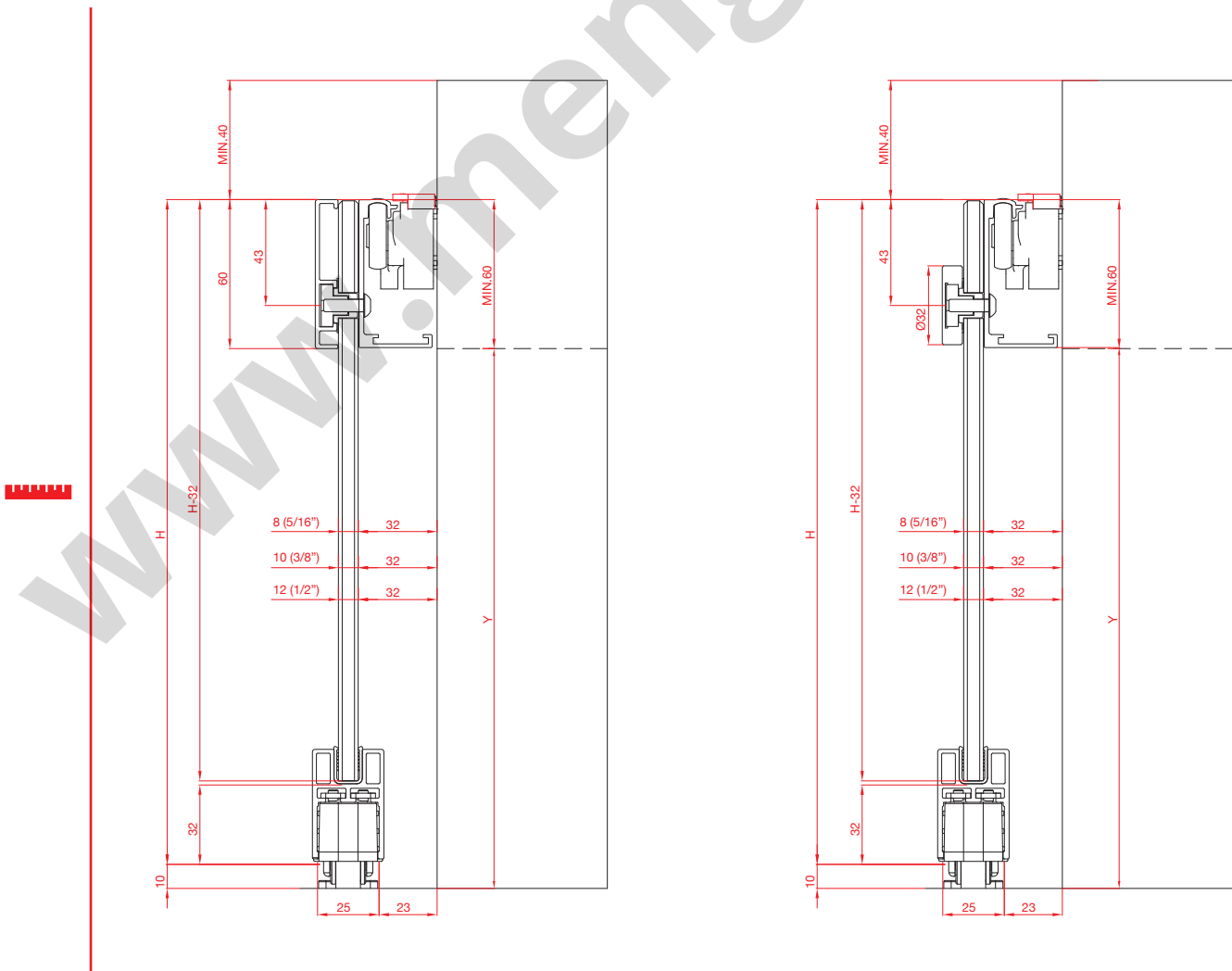

MILLING DESCRIPTION / DESCRIZIONE DELLE LAVORAZIONI

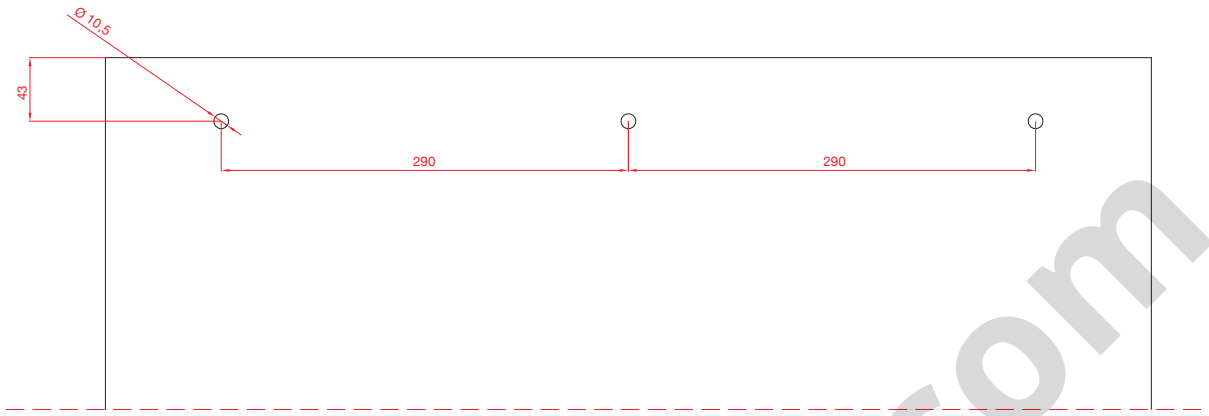

PROFILES CUTTING MEASUREMENTS / MISURE DI TAGLIO DEI PROFILI

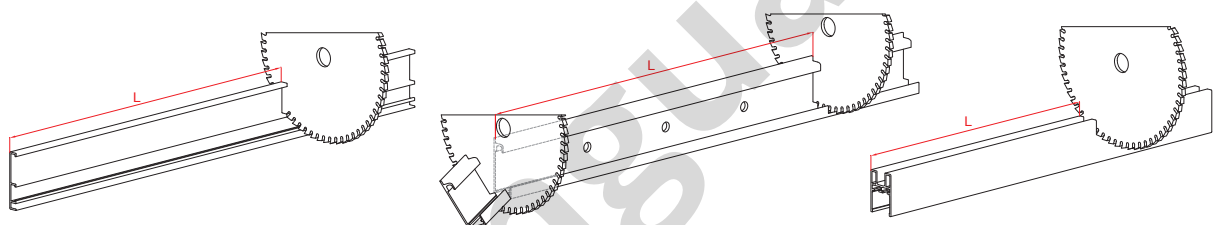

ART. 2199

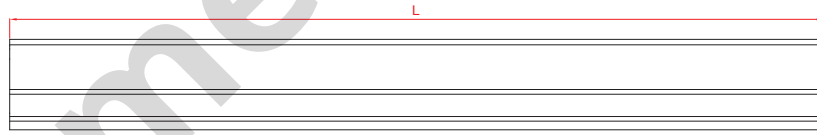

ART. 2198 (8000.02198)

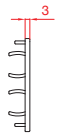

ART. 2199



ART. 2851

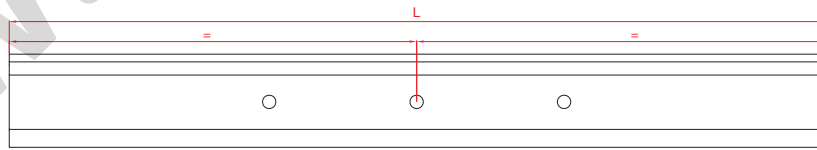

ART. 2850 (8000.02850)



ART. 2851



ART. 2866

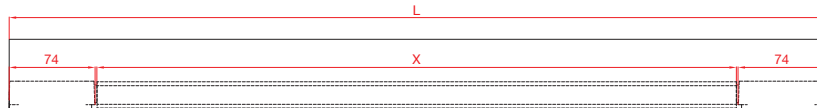

ART. 2863 (8000.02863) - ART. 2862 (8000.02862) - ART. 2861 (8000.02861)

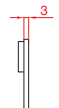

ART. 2866

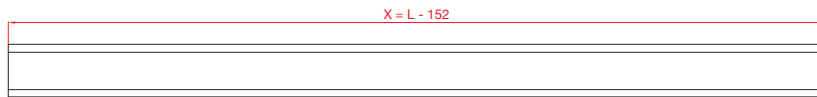

ART. 2860 (8230.02860)

ACCESSORIES PLACEMENT (STANDARD POSITION) / POSIZIONAMENTO DEGLI ACCESSORI (POSIZIONE STANDARD)

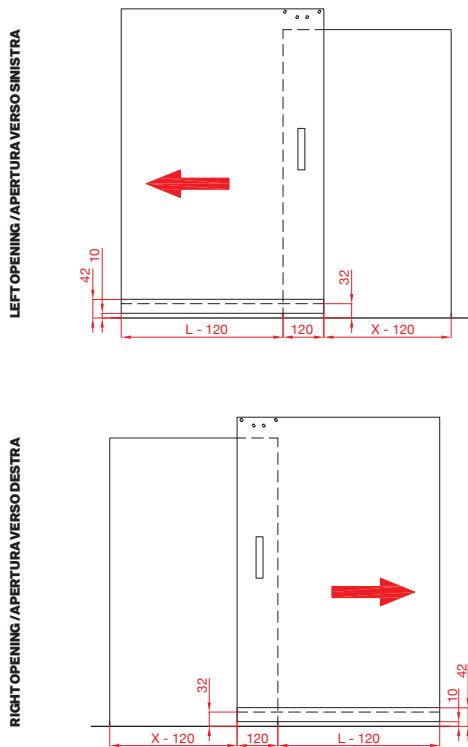

B=0mm (Min.)
B=50mm (Suggested/Suggerito)

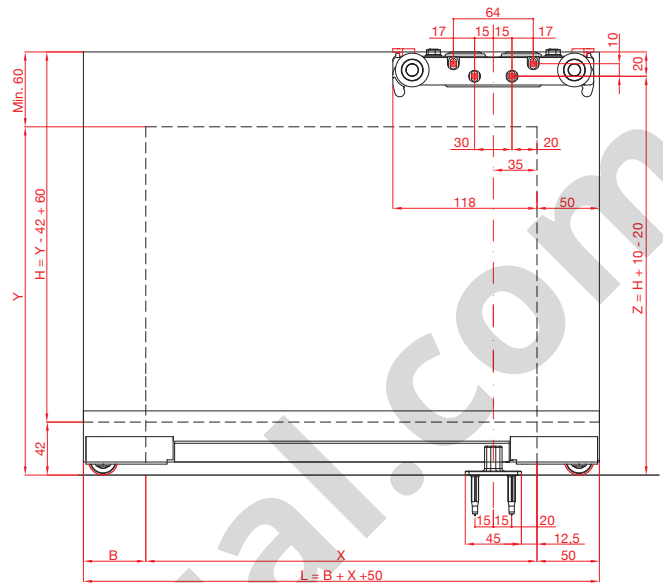

ART. MAGIC2/1100/V/... (K.0041 ...) B=0
X= MIN. 800 (L=850) / X= MAX. 1050 (L=1100)

ART. MAGIC2/1800/V/... (K.0042 ...) B=0
X= MIN. 800 (L=850) / X= MAX. 1750 (L=1800)

ART. MAGIC2/1100/V/... (K.0041 ...) B=50
X= MIN. 800 (L=900) / X= MAX. 1000 (L=1100)

ART. MAGIC2/1800/V/... (K.0042 ...) B=50
X= MIN. 800 (L=900) / X= MAX. 1700 (L=1800)

ACCESSORIES PLACEMENT (INTERMEDIATE POSITION) / POSIZIONAMENTO DEGLI ACCESSORI (POSIZIONE INTERMEDIA)

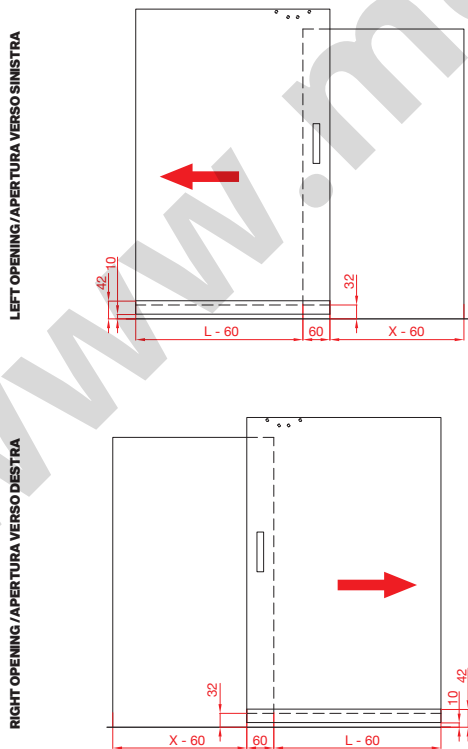

B=0mm (Min.)
B=50mm (Suggested/Suggerito)

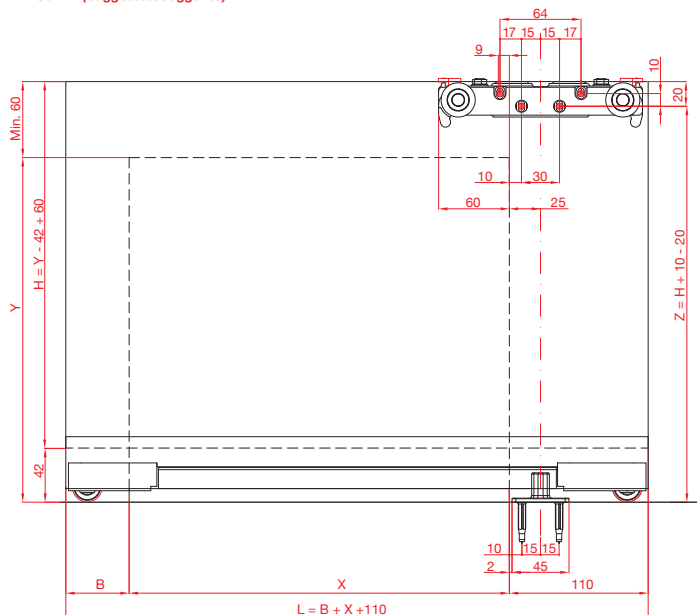

ART. MAGIC2/1100/V/... (K.0041 ...) B=0
X= MIN. 740 (L=850) / X= MAX. 990 (L=1100)

ART. MAGIC2/1800/V/... (K.0042 ...) B=0
X= MIN. 740 (L=850) / X= MAX. 1690 (L=1800)

ART. MAGIC2/1100/V/... (K.0041 ...) B=50
X= MIN. 740 (L=900) / X= MAX. 940 (L=1100)

ART. MAGIC2/1800/V/... (K.0042 ...) B=50
X= MIN. 740 (L=900) / X= MAX. 1640 (L=1800)

ACCESSORIES PLACEMENT (TOTAL OPENING POSITION) / POSIZIONAMENTO DEGLI ACCESSORI (POSIZIONE APERTURA TOTALE)

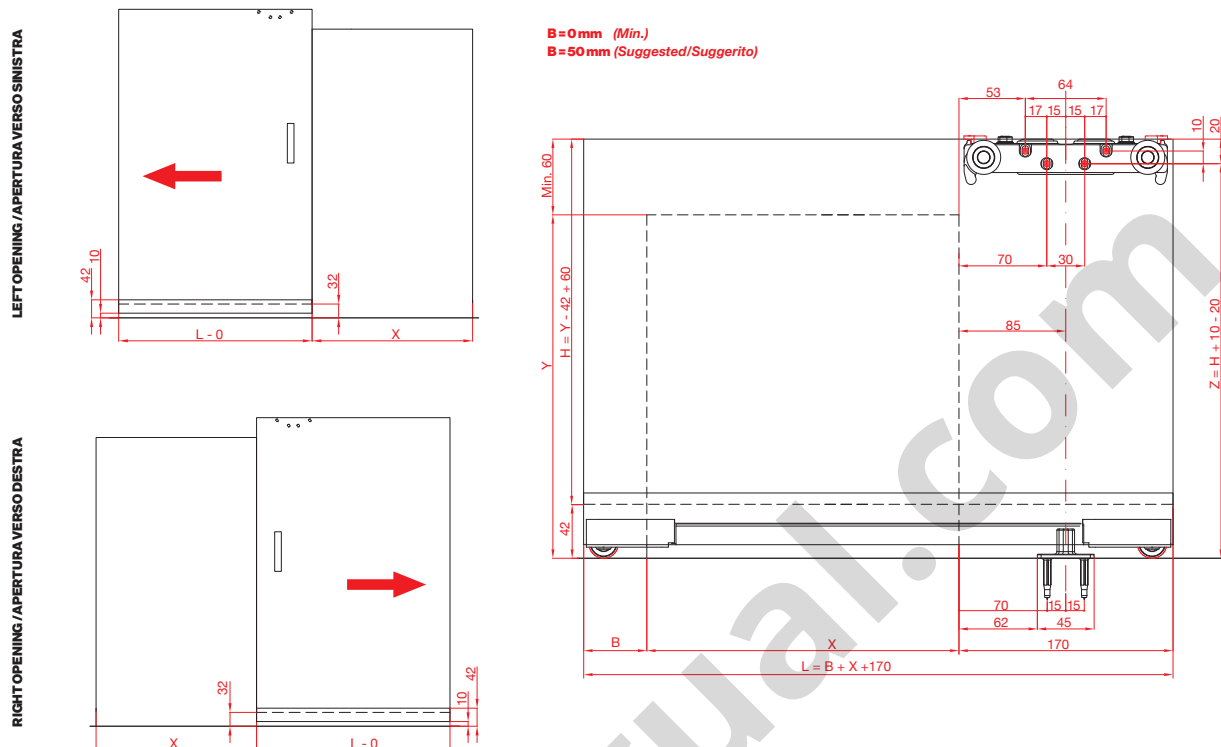

ART. MAGIC2/1100/V/... (K.0041 ...) B=0
X= MIN. 680 (L=850) / X= MAX. 930 (L=1100)

ART. MAGIC2/1100/V/... (K.0041 ...) B=50
X= MIN. 680 (L=900) / X= MAX. 880 (L=1100)

ART. MAGIC2/1800/V/... (K.0042 ...) B=0
X= MIN. 680 (L=850) / X= MAX. 1630 (L=1800)

ART. MAGIC2/1800/V/... (K.0042 ...) B=50
X= MIN. 680 (L=900) / X= MAX. 1580 (L=1800)

www.menabual.com