

Montaje Cajón Milán h=250

Components

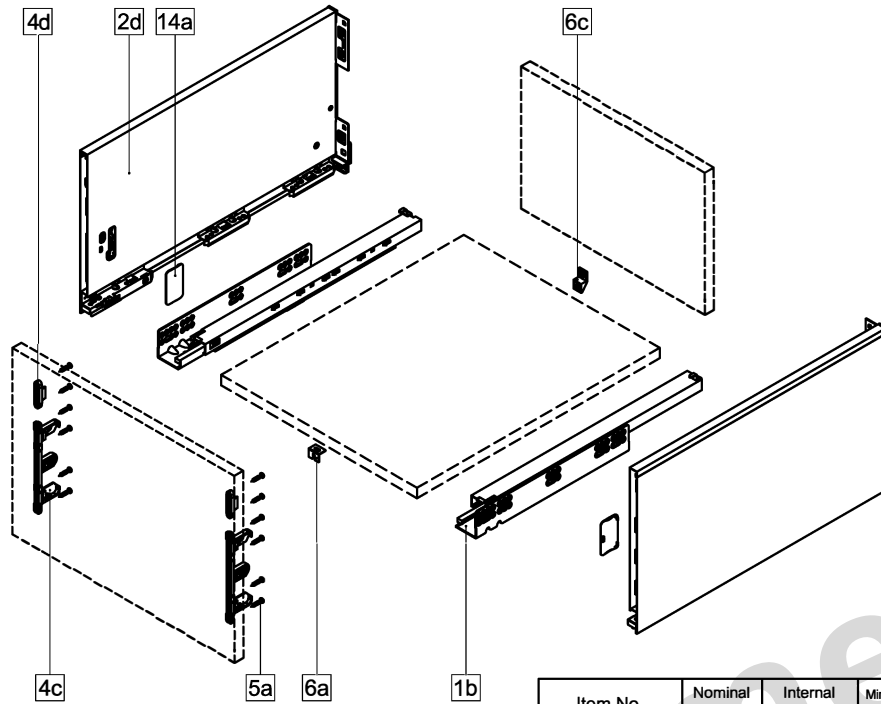

1b. Cabinet profiles L/R	5a. Front fixing-brackets screw (Ø4x17)
2d. 249 Drawer Sides L/R	6a. Front fixing (for wide drawer)
4c. 185 Front fixing-brackets	6c. Back fixing (for wide drawer)
4d. 249 Front fixing-brackets	14a. Side cover plate

Item No.	Nominal length	Internal drawer length	Min. installation length of drawer
808BR249270	270mm	244mm	275mm
808BR249300	300mm	274mm	305mm
808BR249350	350mm	324mm	355mm
808BR249400	400mm	374mm	405mm
808BR249450	450mm	424mm	455mm
808BR249500	500mm	474mm	505mm
808BR249550	550mm	524mm	555mm
808BR249600	600mm	574mm	605mm
808BR249650	650mm	624mm	655mm

Drawer Back and Bottom Dimensions (mm)

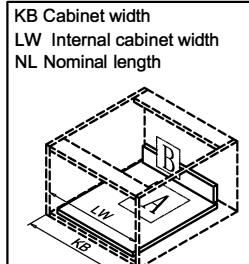
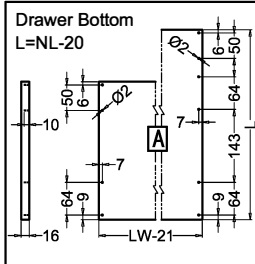
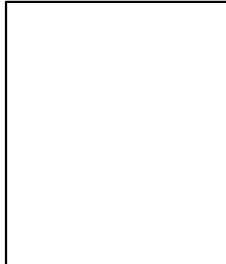
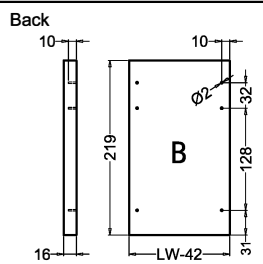

Installation dimensions (mm)

Nominal slide length=NL Internal cabinet depth=LT

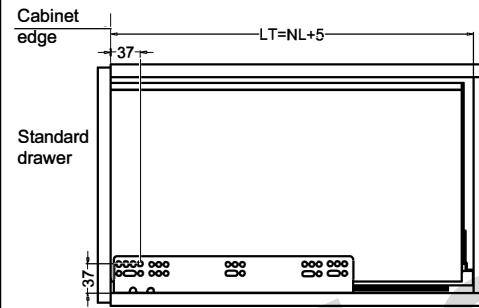

Drawer installation dimensions (mm)

249 Drawer front

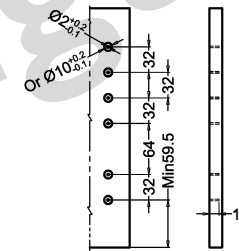

Selection	Drill Size
Wood screw	Ø2 x 12
Anchor bolt	Ø10 x 12

Screw positions of the sides (mm)

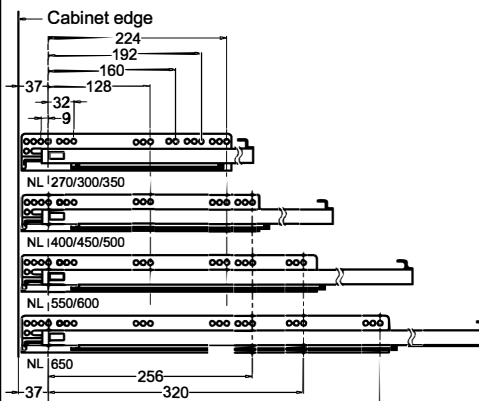

Drawer installation dimensions (mm)

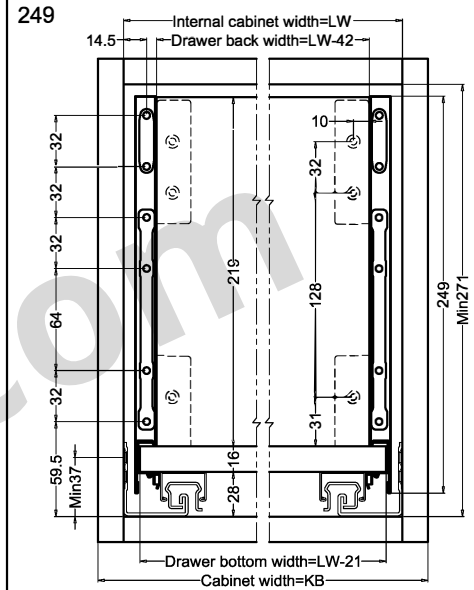

Montaje Cajón Milán h=250

Assembly

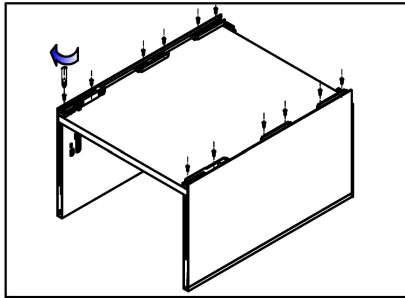

Bottom assembly

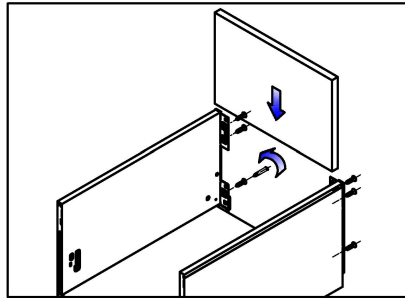

Back assembly

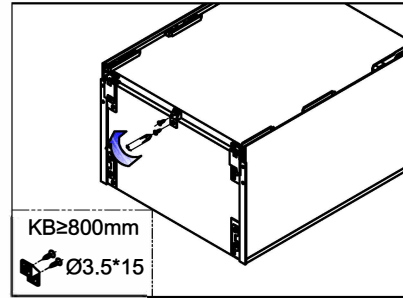

Back fixing assembly

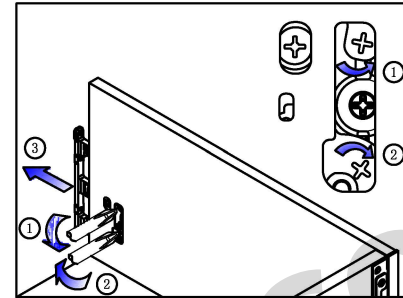

Front bracket release

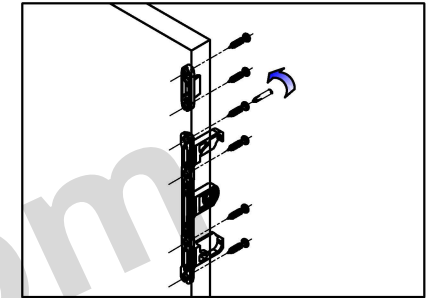

Front bracket assembly

Assembly

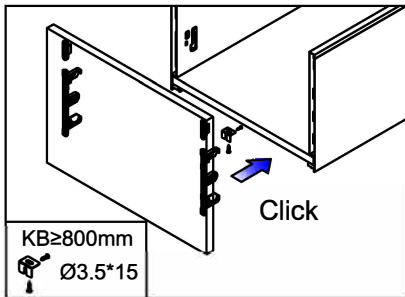

Front assembly

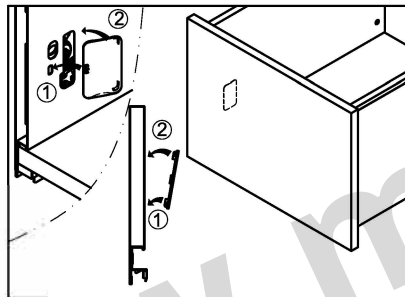

Inside Wall Cover assembly

Adjustment

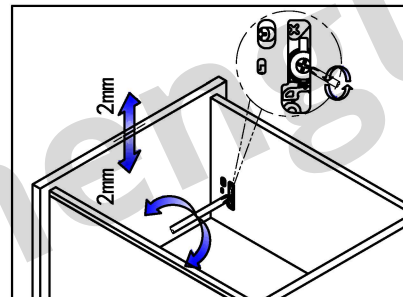

Up&down adjustment

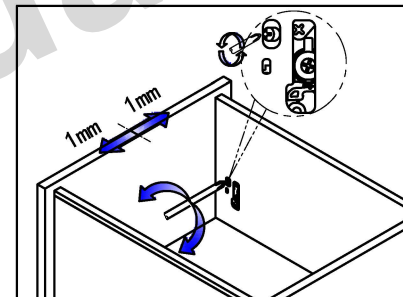

Left&right adjustment

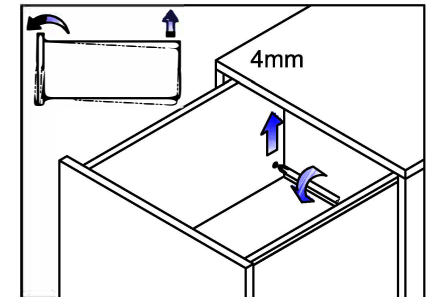

Front slope angle adjustment

Removal

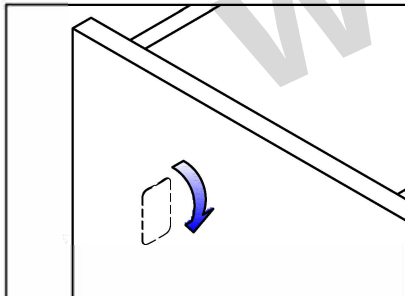

Tip up the cover and pull out

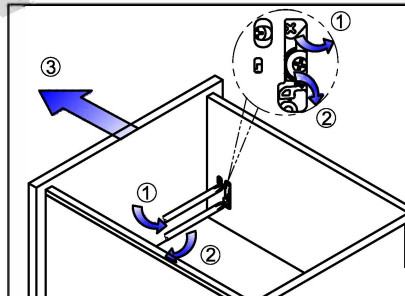

Removal drawer front

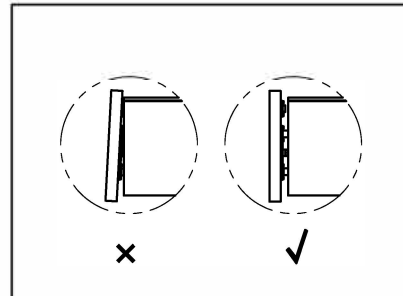

Move the drawer front out horizontally

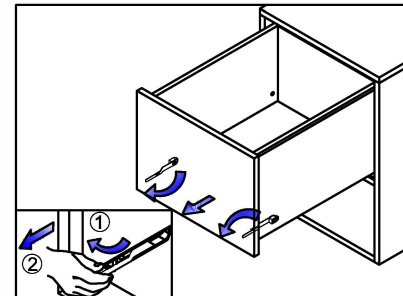

Removal drawer

